

**SFF2006DSU**

SUPER FAST RECOVERY RECTIFIERS



**VOLTAGE:** 600 Volts    **CURRENT:** 20 Amperes    **Package:** TO-252    **Marking And Polarity**

**FEATURES**

- Glass Passivated Chip Junction
- Low Forward Voltage Drop For High Efficiency
- Low Leakage Current For High Reliability
- High Forward Surge Capability For High Reliability
- Fast Reverse Recovery Time

**MECHANICAL DATA**

- **Package:** Molding Compound Meets UL 94 V-0 Flammability Rating, RoHS-Compliant
- **Polarity:** As Marked On Case
- **Mounting Position:** Any
- **Weight:** App. 0.321 Grams (0.01132 Ounce)

**TYPICAL APPLICATIONS**

- Typical Applications Are In Switching Power Supplies, High Frequency Converter, UPS, Freewheeling Diodes, PFC Boost And LED Driver Etc.

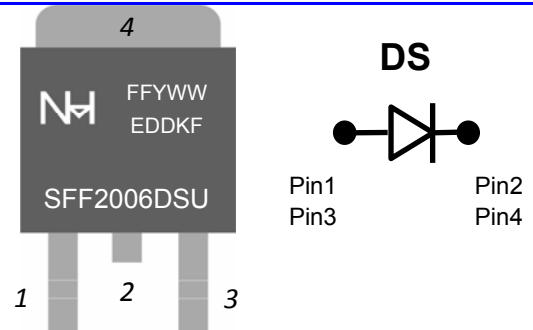

**Remark:**

- ①. NH=niuhang trademark
- ②. FF=Product line code,According to actual changes  
YWW=Date code,According to actual changes  
EDDKF=Inernal code,According to actual changes
- ③. SFF2006DSU=Model

Single Phase,Half Wave,60Hz,Resistive Or Inductive Load.For Capacitive Load,Derate Current By 20%

**Maximum Ratings (Ta=25°C Unless otherwise specified)**

Parameter	Test Conditions	Symbol	SFF2006DSU	Unit
Maximum Repetitive Peak Reverse Voltage		$V_{RRM}$	600	V
Maximum RMS Voltag		$V_{RMS}$	420	V
Maximum DC Blocking Voltage		$V_{DC}$	600	V
Maximum Average Forward Rectified Current	@TC= 100 °C	$I_{F(AV)}$	20	A
Peak Forward Surge Current	8.3ms Single Half Sine-wave Superimposed On Rate Load	$I_{FSM}$	150	A
Current Squared Time Per Diode	t<8.3ms	$I^2t$	93.4	A <sup>2</sup> sec

**Electrical Characteristics (Ta=25°C Unless otherwise specified )**

Parameter	Test Conditions		Symbol	SFF2006DSU			Unit
				Min.	Typ.	Max.	
Instaneous forward voltage per diode (note1)	Ta=25°C	$I_F = 20.0 A$	$V_F$	--	1.35	1.60	V
	Ta=125°C			--	1.22	1.50	
Maximum DC Reverse Current at Rated DC Blocking Voltage (Note 1)	Ta=25°C	$V_R = V_{RRM}$	$I_{RRM}$	--	1	10	µA
	Ta=125°C	$V_R = 80% * V_{RRM}$		--	1	5	mA
Typical Junction Capacitance Per Diode	4.0 V, 1MHz		$C_J$	--	45	--	pF
Maximum Reverse Recovery Time	$I_F = 0.5A, I_R = 1.0A, I_{RR} = 0.25A$		$T_{RR}$	--	35	50	nS

**Thermal Characteristics (Ta=25°C Unless otherwise specified )**

Parameter	Symbol	SFF2006DSU		Unit
Operating Junction Temperature Range	$T_J$	-55	to 150	°C
Storage Temperature Range	$T_{STD}$	-55	to 150	
Typical thermal resistance (Note 2)	$R_{θJA}$	50		°C/W
	$R_{θJC}$	5		

Notes: 1.Pulse Test: 300 Us Pulse Width,1% Duty Cycle

2.Device Mounted On Device Mounted On 10cm\*10cm\*1mm copper pad areas.

SFF2006DSU

SUPER FAST RECOVERY RECTIFIERS



Typical Characteristics Curves

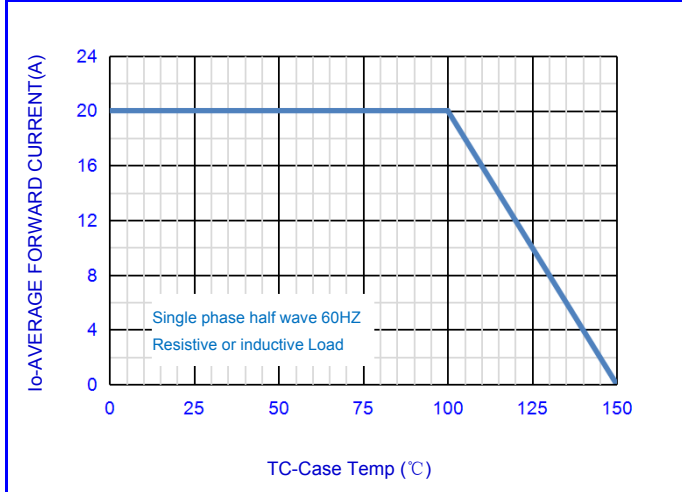

Fig.1-FORWARD CURRENT DERATING CURVE

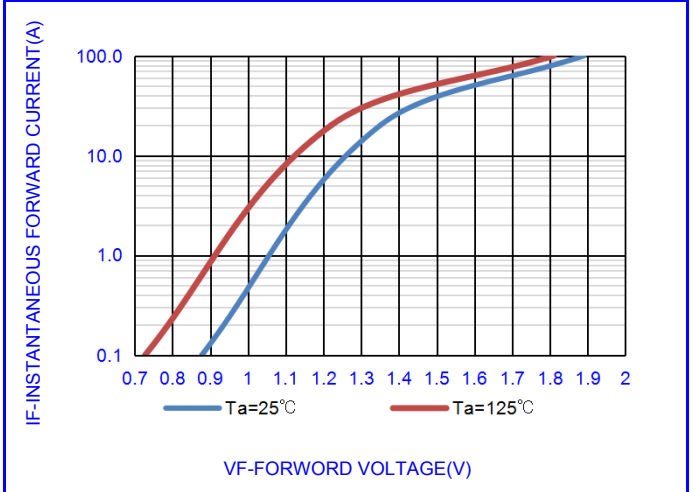

Fig.2- TYPICAL INSTANTANEOUS FORWARD

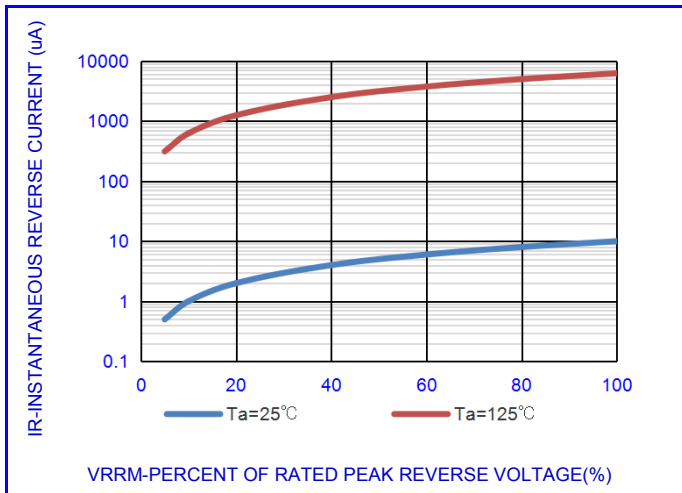

Fig.3- TYPICAL REVERSE CHARACTERISTICS

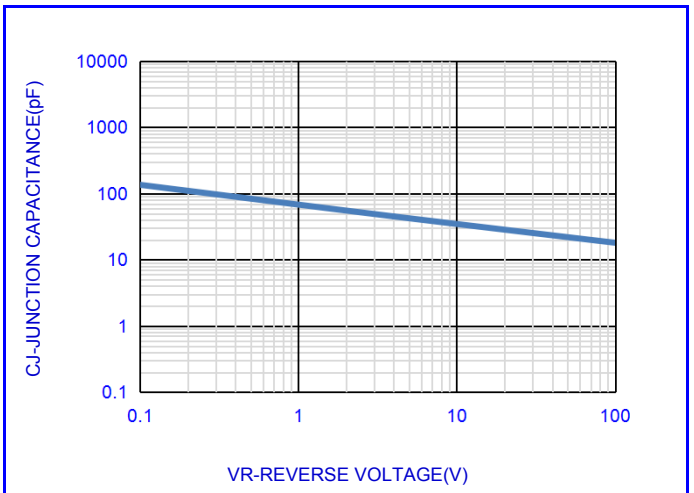

Fig.4- TYPICAL JUNCTION CAPACITANCE

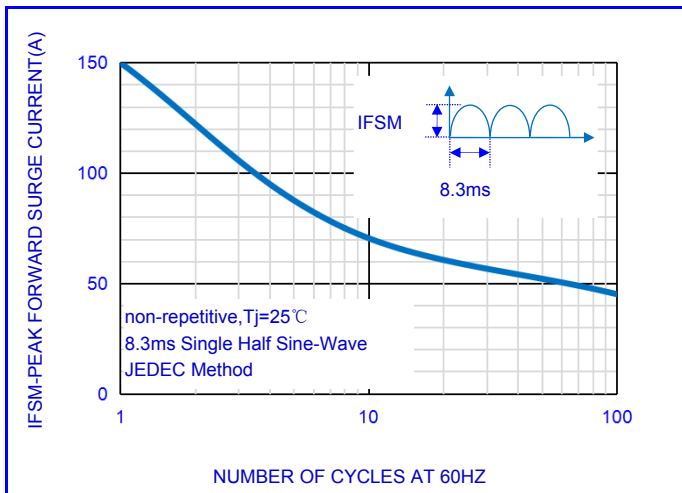

Fig.5-MAX. NON-REPETITIVE SURGE CURRENT

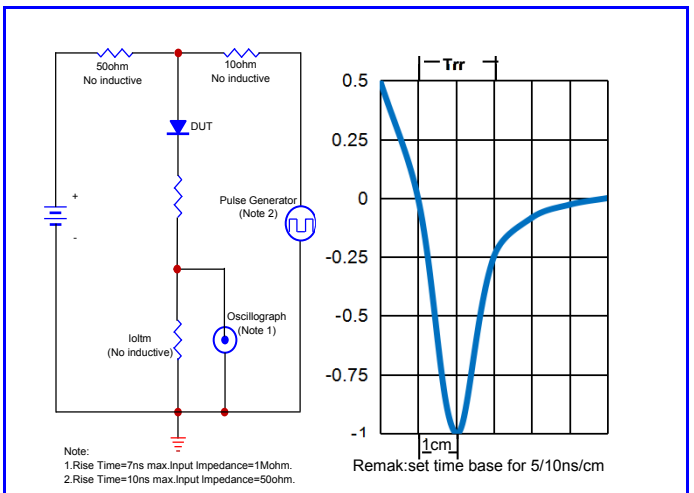

Fig.6-REVERSE RECOVERY TIME CHARACTERISTIC AND TEST CIRCUIT

SFF2006DSU

SUPER FAST RECOVERY RECTIFIERS



OUTLINE DRAWINGS

TO-252

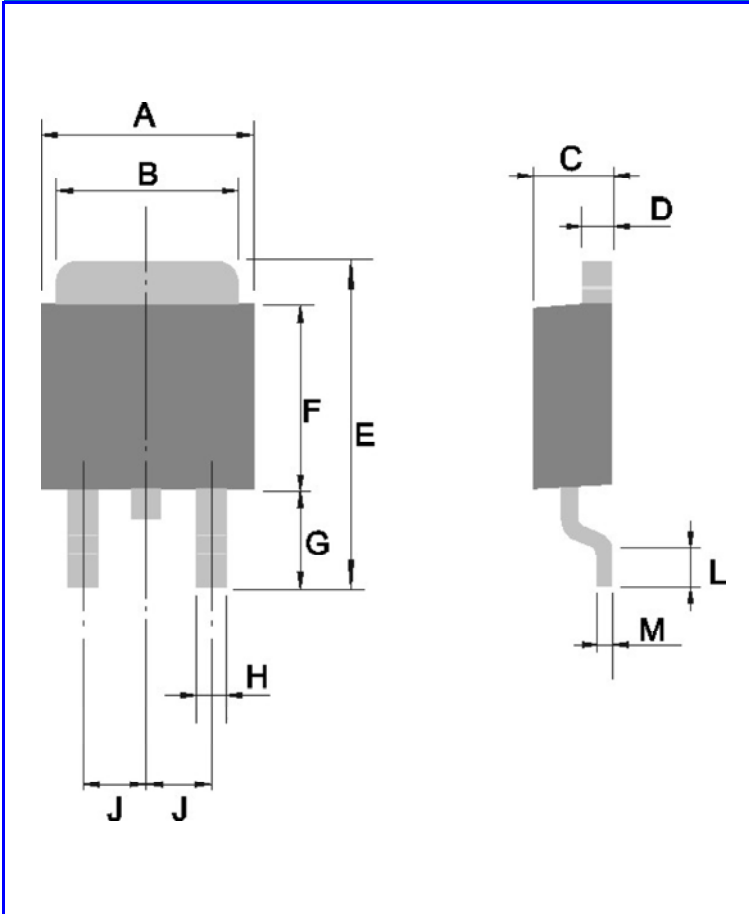

OUTLINE DIMENSIONS						
Dim.	Millimeters			Inches		
	Min.	Typ.	Max.	Min.	Typ.	Max.
A	6.100	-	7.100	0.240	-	0.280
B	4.800	-	5.800	0.189	-	0.228
C	1.950	-	2.550	0.077	-	0.100
D	0.350	-	0.750	0.014	-	0.030
E	9.250	-	10.750	0.364	-	0.423
F	5.600	-	6.600	0.220	-	0.260
G	2.500	-	3.100	0.098	-	0.122
H	0.650	-	1.050	0.026	-	0.041
J	2.100	-	2.500	0.083	-	0.098
L	1.000	-	1.400	0.039	-	0.055
M	0.350	-	0.750	0.014	-	0.030

OUTLINE DRAWINGS

TO-252

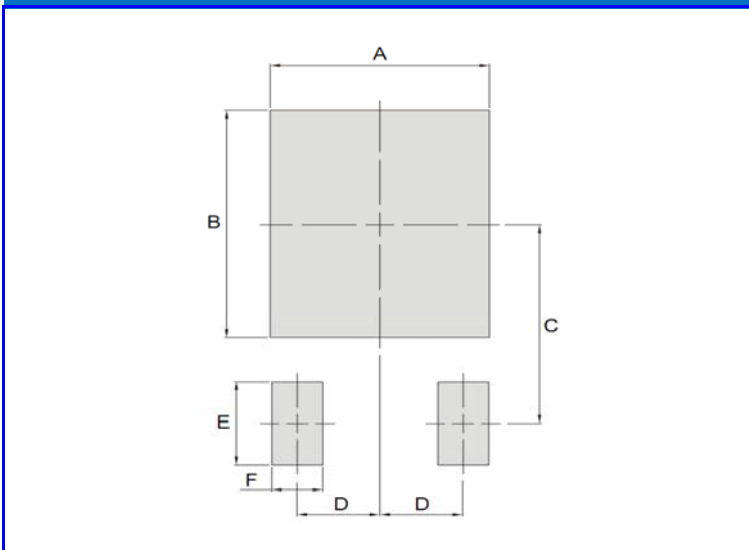

OUTLINE DIMENSIONS						
Dim.	Millimeters			Inches		
	Min.	Typ.	Max.	Min.	Typ.	Max.
A	-	6.09	-	-	0.24	-
B	-	7.57	-	-	0.298	-
C	-	6.64	-	-	0.261	-
D	-	2.3	-	-	0.091	-
E	-	2.76	-	-	0.109	-
F	-	1.42	-	-	0.056	-

PACKING INFORMATION

Package Code	Package Method	Inner Box Size L×W×H(mm)	Quantity (Pcs/Inner Box)	Outer Carton Size L×W×H(mm)	Quantity (Pcs/Carton)
TO-252	T/R	340×340×50	5000	360×360×260	25000

SFF2006DSU

SUPER FAST RECOVERY RECTIFIERS



Recommended wave soldering condition

Product	Peak Temperature	Soldering Time
Pb-free devices	260 +0/-5 °C	5 +1/-1 seconds

Recommended temperature profile for IR reflow

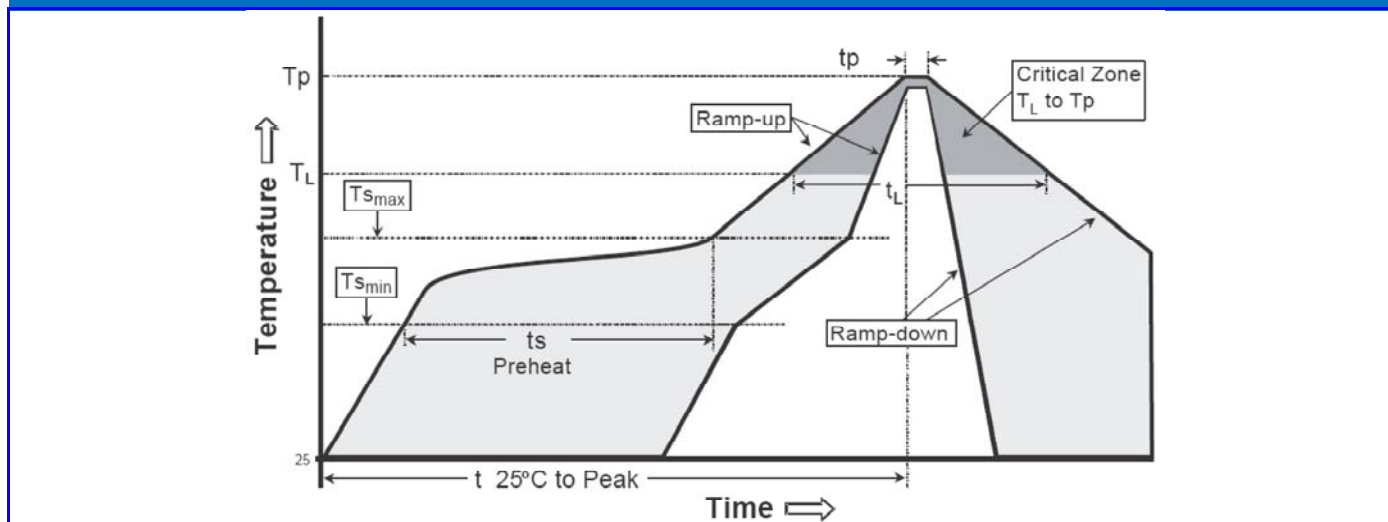

Profile feature	Sn-Pb eutectic Assembly	Pb-free Assembly
Average ramp-up rate (T <sub>smax</sub> to T <sub>p</sub> )	3°C/second max.	3°C/second max.
Preheat -Temperature Min(T <sub>S min</sub> ) -Temperature Max(T <sub>S max</sub> ) -Time( $t_s$ min to $t_s$ max)	100°C 150°C 60-120 seconds	150°C 200°C 60-180 seconds
Time maintained above: -Temperature (T <sub>L</sub> ) - Time (t <sub>L</sub> )	183°C 60-150 seconds	217°C 60-150 seconds
Peak Temperature(T <sub>P</sub> )	240 +0/-5 °C	260 +0/-5 °C
Time within 5°C of actual peak temperature( $t_p$ )	10-30 seconds	20-40 seconds
Ramp down rate	6°C/second max.	6°C/second max.
Time 25 °C to peak temperature	6 minutes max.	8 minutes max.

Note : All temperatures refer to topside of the package, measured on the package body surface.

**SFF2006DSU**

SUPER FAST RECOVERY RECTIFIERS



**Disclaimer**

- Reproducing and modifying information of the document is prohibited without permission from niuhang Electronics co., LTD
- Nihang Electronics co., LTD. reserves the rights to make changes of the content herein the document anytime without notification.
- Nihang Electronics co., LTD. disclaims any and all liability arising out of the application or use of any product including damages incidentally and consequentially occurred.
- Nihang Electronics co., LTD. does not assume any and all implied warranties, including warranties of fitness for particular purpose, non-infringement and merchantability.
- Applications shown on the herein document are examples of standard use and operation. Customers are responsible in comprehending the suitable use in particular applications. Nihang Electronics co., LTD. makes no representation or warranty that such applications will be suitable for the specified use without further testing or modification.
- The products shown herein are not designed and authorized for equipments requiring high level of reliability or relating to human life and for any applications concerning life-saving or life-sustaining, such as medical instruments, transportation equipment, aerospace machinery et cetera. Customers using or selling these products for use in such applications do so at their own risk and agree to fully indemnify Nihang Electronics co., LTD. for any damages resulting from such improper use or sale.
- When the appearance of the product and chip size does not change, in order to product the customer. quality, change the internal structure and the production process Nihang can not notify