

Description

The AOD409 is the high cell density trenched P-ch MOSFETs, which provide excellent RDS(on) and gate charge for most of the synchronous buck converter applications. The AOD409 meet the RoHS and Green Product requirement, 100% EAS guaranteed with full function reliability approved.

Super Low Gate Charge
 100% EAS Guaranteed
 Green Device Available
 Excellent CdV/dt effect decline
 Advanced high cell density Trench technology

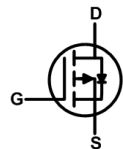
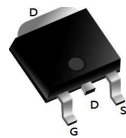

Product Summary

BVDSS	RDS(on)	ID
-60V	23mΩ	-45A

TO-252

Unit: mm

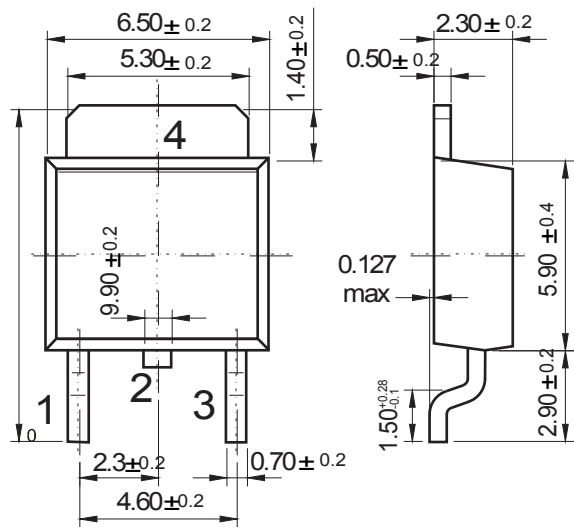

Dimensions in inches and (millimeters)

Absolute Maximum Ratings

Symbol	Parameter	Rating	Units
V _{DS}	Drain-Source Voltage	-60	V
V _{GS}	Gate-Source Voltage	±20	V
I _D @T _C =25°C	Continuous Drain Current, -V _{GS} @ -10V ¹	-45	A
I _D @T _C =100°C	Continuous Drain Current, -V _{GS} @ -10V ¹	-27	A
I _{DM}	Pulsed Drain Current ²	-70	A
EAS	Single Pulse Avalanche Energy ³	113	mJ
I _{AS}	Avalanche Current	47.6	A
P _D @T _C =25°C	Total Power Dissipation ⁴	52.1	W
T _{STG}	Storage Temperature Range	-55 to 150	°C
T _J	Operating Junction Temperature Range	-55 to 150	°C

Thermal Data

Symbol	Parameter	Typ.	Max.	Unit
R _{θJA}	Thermal Resistance Junction-Ambient ¹	---	62	°C/W
R _{θJC}	Thermal Resistance Junction-Case ¹	---	2.4	°C/W

AOD409

Electrical Characteristics (T_J=25 °C, unless otherwise noted)

Symbol	Parameter	Conditions	Min.	Typ.	Max.	Unit
BV _{DSS}	Drain-Source Breakdown Voltage	V _{GS} =0V, I _D =-250uA	-60	---	---	V
ΔBV _{DSS} /ΔT _J	BV _{DSS} Temperature Coefficient	Reference to 25°C, I _D =-1mA	---	-0.035	---	V/°C
R _{DS(ON)}	Static Drain-Source On-Resistance ²	V _{GS} =-10V, I _D =-18A	---	23	27	mΩ
		V _{GS} =-4.5V, I _D =-12A	---	26	33	
V _{GS(th)}	Gate Threshold Voltage	V _{GS} =V _{DS} , I _D =-250uA	-1.0	---	-2.5	V
ΔV _{GS(th)}	V _{GS(th)} Temperature Coefficient		---	4.28	---	mV/°C
I _{DSS}	Drain-Source Leakage Current	V _{DS} =-48V, V _{GS} =0V, T _J =25°C	---	---	1	uA
		V _{DS} =-48V, V _{GS} =0V, T _J =55°C	---	---	5	
I _{GSS}	Gate-Source Leakage Current	V _{GS} =±20V, V _{DS} =0V	---	---	±100	nA
g _{fs}	Forward Transconductance	V _{DS} =-10V, I _D =-18A	---	23	---	S
R _g	Gate Resistance	V _{DS} =0V, V _{GS} =0V, f=1MHz	---	7	---	Ω
Q _g	Total Gate Charge (-4.5V)	V _{DS} =-20V, V _{GS} =-4.5V, I _D =-12A	---	25	---	nC
Q _{gs}	Gate-Source Charge		---	6.7	---	
Q _{gd}	Gate-Drain Charge		---	5.5	---	
T _{d(on)}	Turn-On Delay Time	V _{DD} =-15V, V _{GS} =-10V, R _G =3.3Ω, I _D =-1A	---	38	---	ns
T _r	Rise Time		---	23.6	---	
T _{d(off)}	Turn-Off Delay Time		---	100	---	
T _f	Fall Time		---	6.8	---	
C _{iss}	Input Capacitance	V _{DS} =-15V, V _{GS} =0V, f=1MHz	---	3635	---	pF
C _{oss}	Output Capacitance		---	224	---	
C _{rss}	Reverse Transfer Capacitance		---	141	---	

Diode Characteristics

Symbol	Parameter	Conditions	Min.	Typ.	Max.	Unit
I _S	Continuous Source Current ^{1,5}	V _G =V _D =0V, Force Current	---	---	-45	A
I _{SM}	Pulsed Source Current ^{2,5}		---	---	-70	A
V _{SD}	Diode Forward Voltage ²	V _{GS} =0V, I _S =-1A, T _J =25°C	---	---	-1	V

Note :

- 1.The data tested by surface mounted on a 1 inch² FR-4 board with 2OZ copper.
- 2.The data tested by pulsed , pulse width ≤ 300us , duty cycle ≤ 2%
- 3.The EAS data shows Max. rating . The test condition is V_{DD}=-25V, V_{GS}=-10V, L=0.1mH, I_{AS}=-47.6A
- 4.The power dissipation is limited by 150°C junction temperature
- 5.The data is theoretically the same as I_D and I_{DM} , in real applications , should be limited by total power dissipation.

RATING AND CHARACTERISTIC CURVES (AOD409)

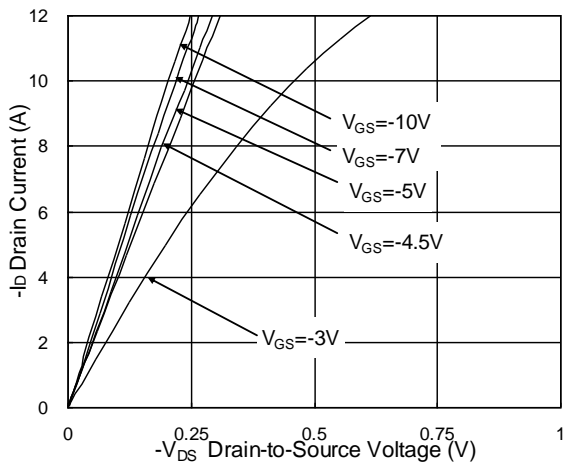

Fig.1 Typical Output Characteristics

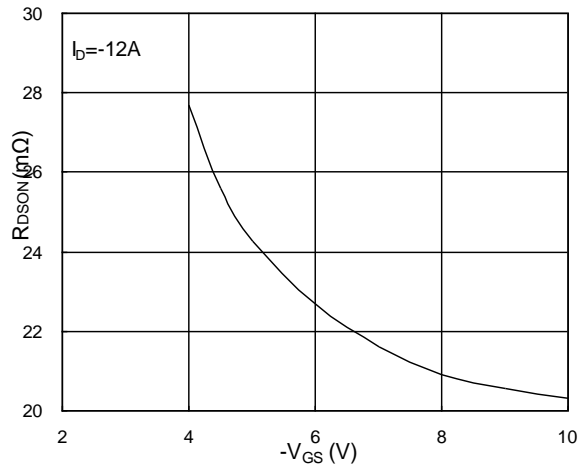

Fig.2 On-Resistance v.s Gate-Source

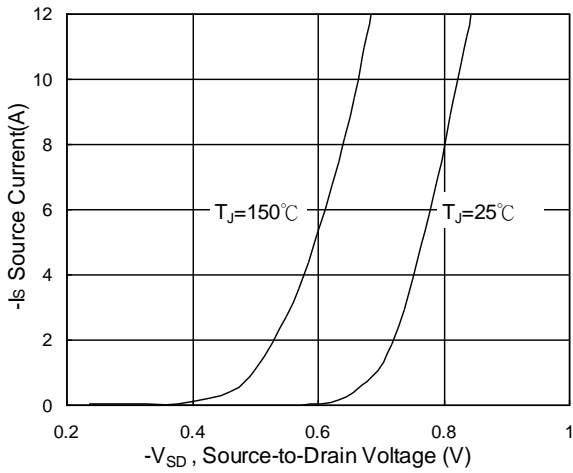

Fig.3 Forward Characteristics Of Reverse

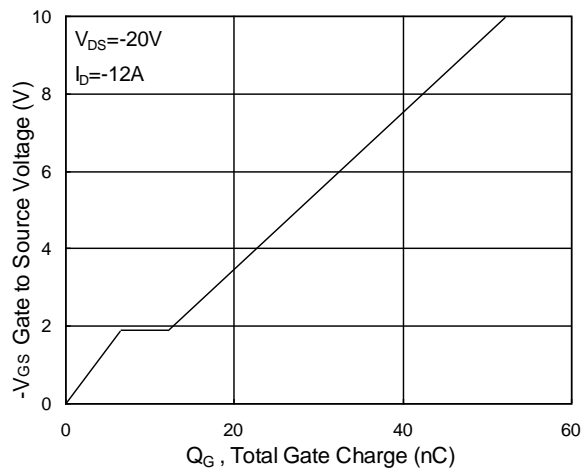

Fig.4 Gate-Charge Characteristics

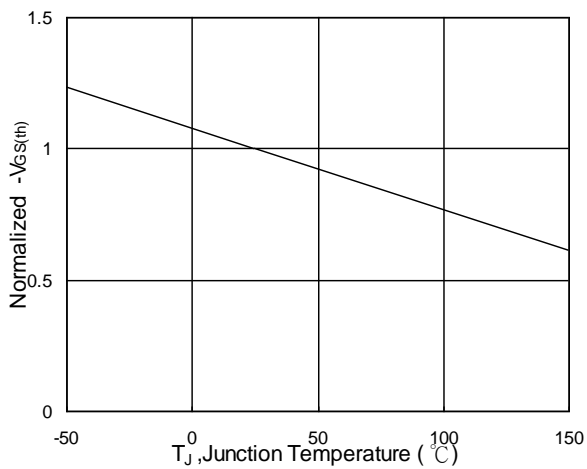

Fig.5 Normalized $V_{GS(th)}$ v.s T_J

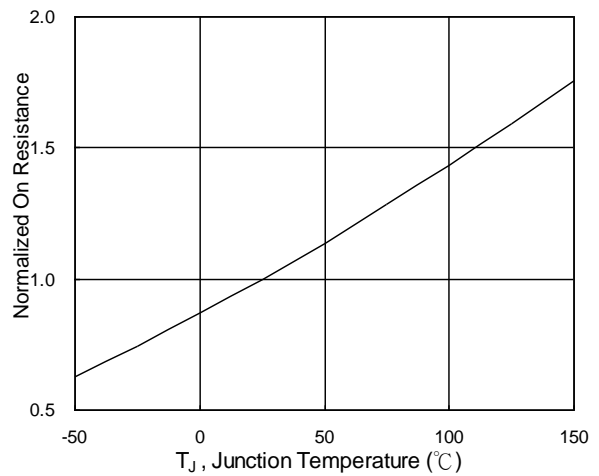

Fig.6 Normalized $R_{DS(on)}$ v.s T_J

RATING AND CHARACTERISTIC CURVES (AOD409)

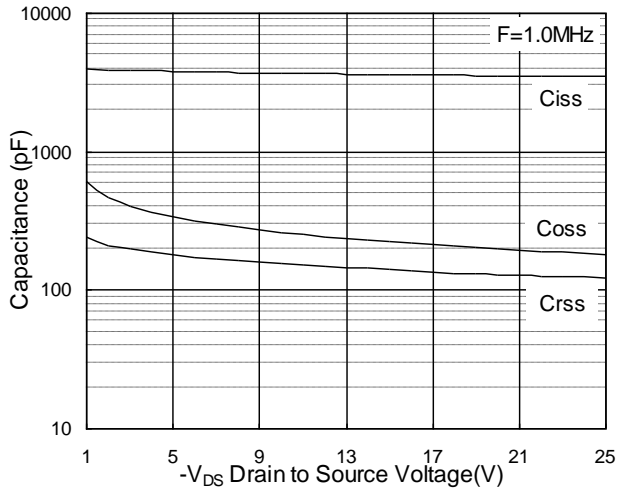

Fig.7 Capacitance

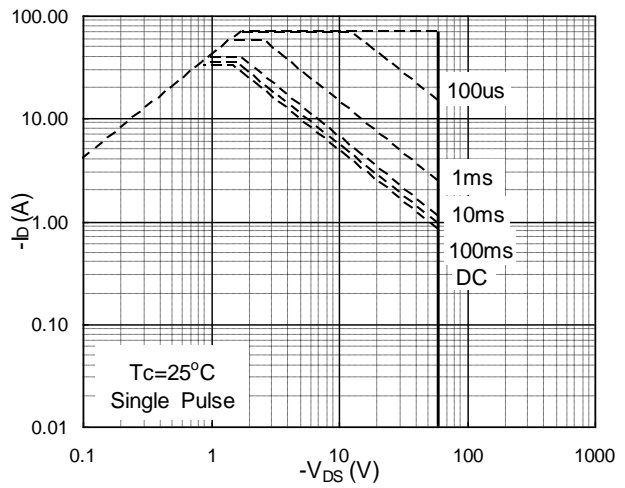

Fig.8 Safe Operating Area

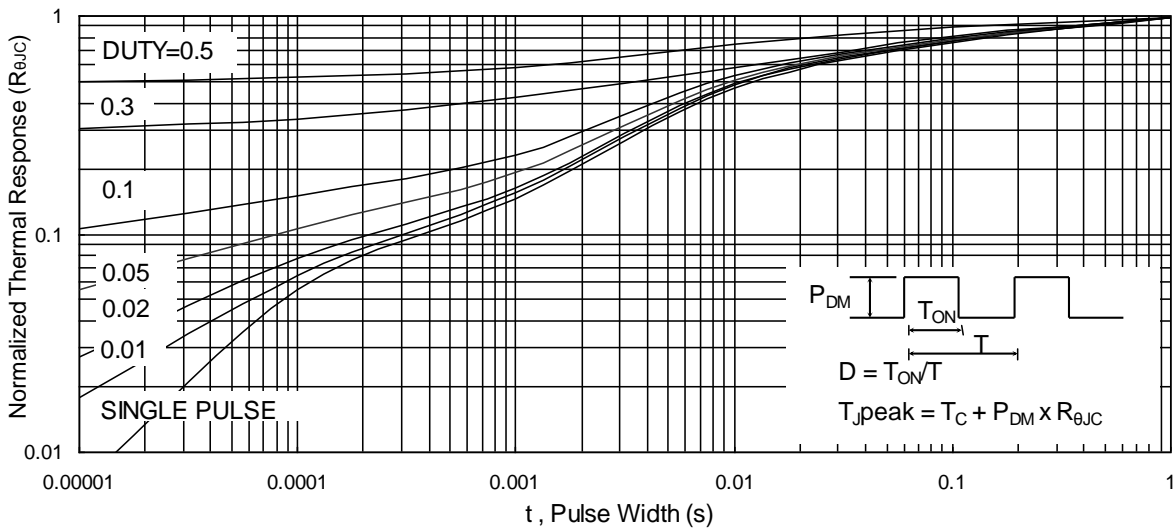

Fig.9 Normalized Maximum Transient Thermal Impedance