

BCZ120N40M1

N-Channel Silicon Carbide Power MOSFET

1200 V, 60 A, 40 mΩ



bestirpower

BV _{DSS} , T _C =25°C	I _D , T _C =25°C	R _{DS(on)} , typ	Q _g , typ
1200 V	60 A	40 mΩ	109nC

Features

- High switching speed with a low gate charge
- Fast intrinsic diode with low reverse recovery
- Robust Avalanche Capability
- 100% Avalanche Tested
- Pb-free, Halogen Free, and RoHS Compliant

Benefits

- System efficiency improvement
- Higher frequency applicability
- Increased power density
- Reduced cooling effort

Applications

- Solar inverter
- EV charging station
- UPS
- Industrial power supply

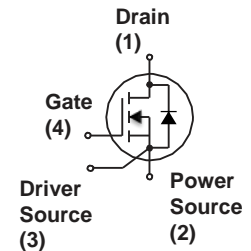

Absolute Maximum Ratings (T_C = 25°C unless otherwise noted)



Symbol	Parameter	Value	Unit
V _{DSS}	Drain to Source Voltage	1200	V
V _{GS}	Gate to Source Voltage (DC)	-10 / +22	V
V _{GSop}	Recommended Operation Value	-5 / +18	V
I _D	Drain Current	Continuous (V _{GS} =18V, T _C =25°C)	60
		Continuous (V _{GS} =18V, T _C =100°C)	42
I _{DM}	Drain Current	Pulsed (Note1)	160
E _{AS}	Avalanche Capability	V _{DD} =100V, V _{GS} =20V, L=2mH	1000
I _{AV}	Avalanche Capability	V _{DD} =100V, V _{GS} =20V, L=2mH	30
P _D	Power Dissipation	(T _C = 25°C)	375
		Derate Above 25°C	2.5
T _J , T _{STG}	Operating and Storage Temperature Range	-55 to 175	°C

※Note 1 : Limited by maximum junction temperature.

Symbol	Parameter	Value	Unit
R _{θJC}	Thermal Resistance, Junction to Case, Max.	0.4	°C/W
R _{θJA}	Thermal Resistance, Junction to Ambient, Max.	34	
T _{sold}	Soldering temperature, wave soldering only allowed at leads	260	°C

Electrical Characteristics (T_C = 25°C unless otherwise noted)

Symbol	Parameter	Test Conditions	Min	Typ	Max	Unit
--------	-----------	-----------------	-----	-----	-----	------

Off Characteristics

BV _{DSS}	Drain to Source Breakdown Voltage	V _{GS} = 0 V, I _D = 1 mA	1200	-	-	V
I _{DSS}	Zero Gate Voltage Drain Current	V _{DS} = 1200 V, V _{GS} = 0 V	-	1	100	μA
		V _{DS} = 1200 V, V _{GS} = 0 V, T _J = 175°C	-	5	-	
I _{GSS}	Gate-Source Leakage Current	V _{GS} = +22 V, V _{DS} = 0 V	-	-	+100	nA
		V _{GS} = -10 V, V _{DS} = 0 V	-	-	-100	

Electrical Characteristics ($T_C = 25^\circ\text{C}$ unless otherwise noted)

Symbol	Parameter	Test Conditions	Min	Typ	Max	Unit
On Characteristics						
$V_{GS(th)}$	Gate Threshold Voltage	$V_{GS} = V_{DS}, I_D = 10\text{ mA}$	2.0	3.0	4.5	V
$R_{DS(on)}$	Static Drain to Source On Resistance	$V_{GS} = 18\text{ V}, I_D = 30\text{ A}$	-	40	56	mΩ
		$V_{GS} = 18\text{ V}, I_D = 30\text{ A}, T_J = 175^\circ\text{C}$	-	51	-	
		$V_{GS} = 15\text{ V}, I_D = 30\text{ A}$	-	50	-	
		$V_{GS} = 15\text{ V}, I_D = 30\text{ A}, T_J = 150^\circ\text{C}$	-	53	-	
		$V_{GS} = 15\text{ V}, I_D = 30\text{ A}, T_J = 175^\circ\text{C}$	-	59	-	
		$V_{GS} = 18\text{ V}, I_D = 40\text{ A}$	-	40	-	
		$V_{GS} = 18\text{ V}, I_D = 40\text{ A}, T_J = 150^\circ\text{C}$	-	54	-	
g_{fs}	Transconductance	$V_{DS} = 20\text{ V}, I_D = 30\text{ A}$	-	15	-	S

Dynamic Characteristics

C_{iss}	Input Capacitance	$V_{DS} = 800\text{ V}, V_{GS} = 0\text{ V}, f = 250\text{ kHz}$	-	1960	-	pF
C_{oss}	Output Capacitance		-	125	-	
C_{riss}	Reverse Capacitance		-	5	-	
E_{oss}	Stored Energy in Output Capacitance	$V_{DS} = 0\text{ V to } 800\text{ V}, V_{GS} = 0\text{ V}$	-	50	-	μJ
$C_{o(er)}$	Energy Related Output Capacitance		-	146	-	pF
$C_{o(tr)}$	Time Related Output Capacitance		-	258	-	
$Q_{g(tot)}$	Total Gate Charge	$V_{DS} = 800\text{ V}, I_D = 30\text{ A},$ $V_{GS} = -5\text{ V} / 18\text{ V}$	-	109	-	nC
Q_{gs}	Gate to Source Charge		-	28	-	
Q_{gd}	Gate to Drain "Miller" Charge		-	35	-	
R_G	Internal Gate Resistance	$f = 1\text{ MHz}, V_{AC} = 30\text{ mV}$	-	3.5	-	Ω

Switching Characteristics

$t_{d(on)}$	Turn-On Delay Time	$V_{DS} = 800\text{ V}, I_D = 30\text{ A},$ $V_{GS} = -5\text{ V} / 18\text{ V},$ $R_G = 2.5\Omega,$ FWD: BCH120S020D1, Inductive load	-	18	-	ns
t_r	Turn-On Rise Time		-	13	-	
$t_{d(off)}$	Turn-Off Delay Time		-	35	-	
t_f	Turn-Off Fall Time		-	8	-	
E_{on}	Turn-on Switching Energy		-	232	-	μJ
E_{off}	Turn-off Switching Energy		-	73	-	
E_{tot}	Total Switching Energy	-	305	-		

Source-Drain Diode Characteristics

I_S	Maximum Continuous Diode Forward Current	-	-	60	A	
I_{SM}	Maximum Pulsed Diode Forward Current	-	-	160		
V_{SD}	Diode Forward Voltage	$V_{GS} = -5\text{ V}, I_{SD} = 30\text{ A}$	-	4.2	-	V
t_{rr}	Reverse Recovery Time	$V_{DD} = 800\text{ V}, I_{SD} = 30\text{ A},$ $dl_f/dt = 3000\text{ A}/\mu\text{s}$	-	22	-	ns
Q_{rr}	Reverse Recovery Charge		-	348	-	nC
t_{rr}	Reverse Recovery Time	$V_{GS} = -5\text{ V}, V_{DD} = 800\text{ V}, I_{SD} = 40\text{ A},$ $dl_f/dt = 4200\text{ A}/\mu\text{s}$	-	13	-	ns
Q_{rr}	Reverse Recovery Charge		-	182	-	nC
I_{rrm}	Peak Reverse Recovery Current		-	23	-	A

Typical Performance Characteristics

Figure 1. On-Region Characteristics $T_J = -40^\circ\text{C}$

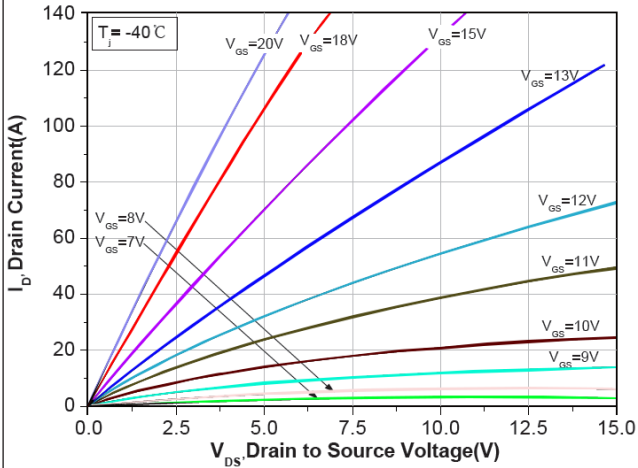

Figure 2. On-Region Characteristics $T_J = 25^\circ\text{C}$

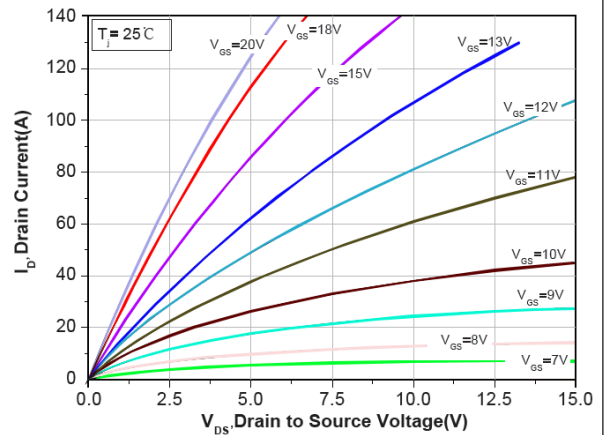

Figure 3. On-Region Characteristics $T_J = 175^\circ\text{C}$

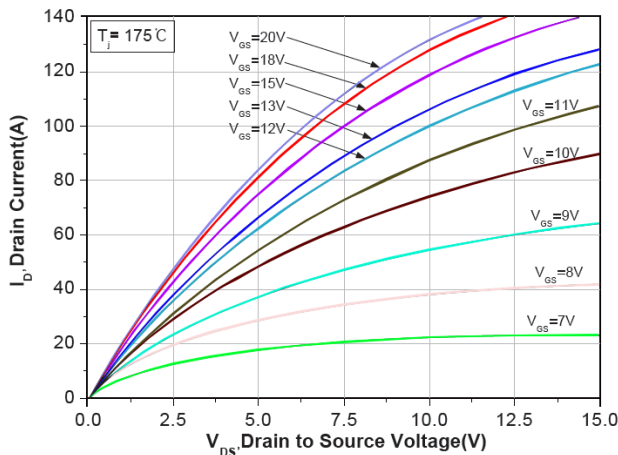

Figure 4. Normalized On-Resistance Characteristics vs. Temperature

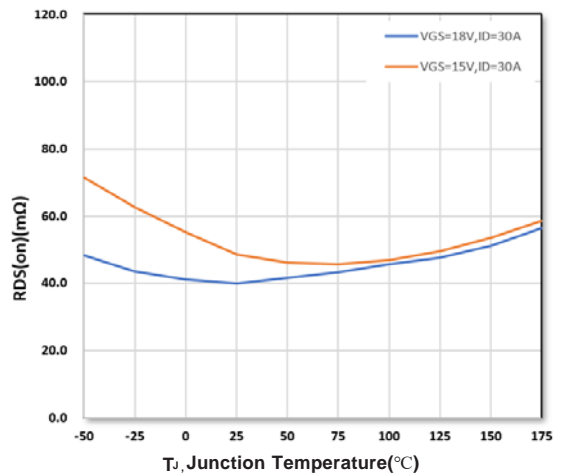

Figure 5. Transfer Characteristics

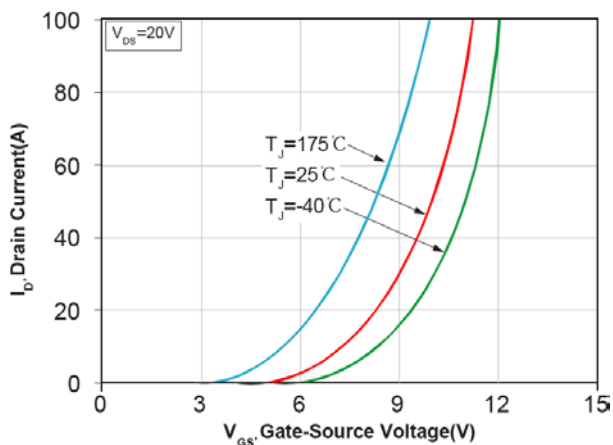
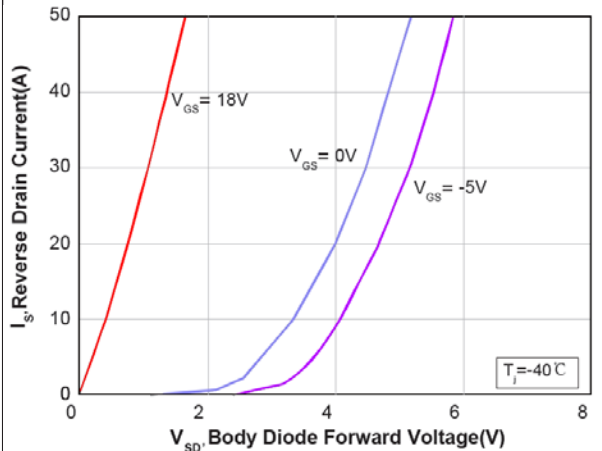

Figure 6. Diode Forward Voltage Characteristics vs. Source-Drain Current $T_J = -40^\circ\text{C}$



Typical Performance Characteristics

Figure 7. Diode Forward Voltage Characteristics vs. Source-Drain Current $T_J = 25^\circ\text{C}$

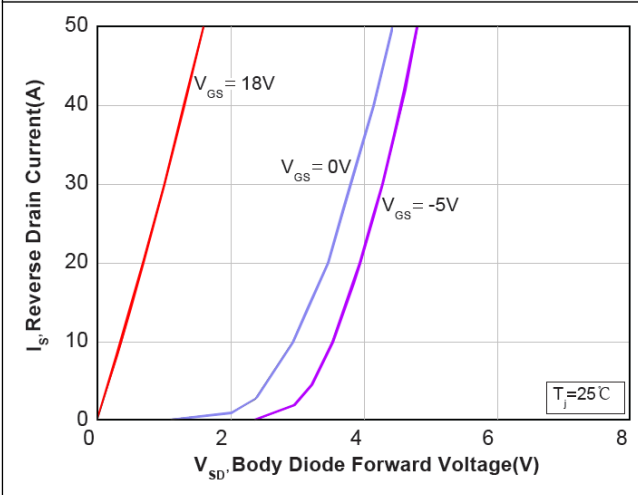

Figure 8. Diode Forward Voltage Characteristics vs. Source-Drain Current $T_J = 175^\circ\text{C}$

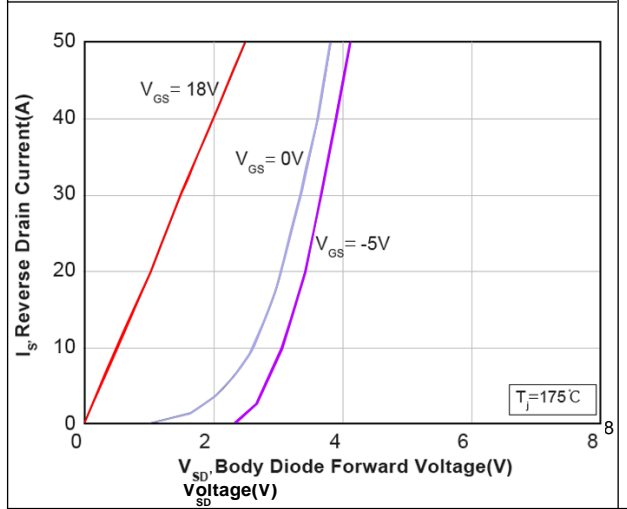

Figure 9. Threshold Voltage vs. Temperature

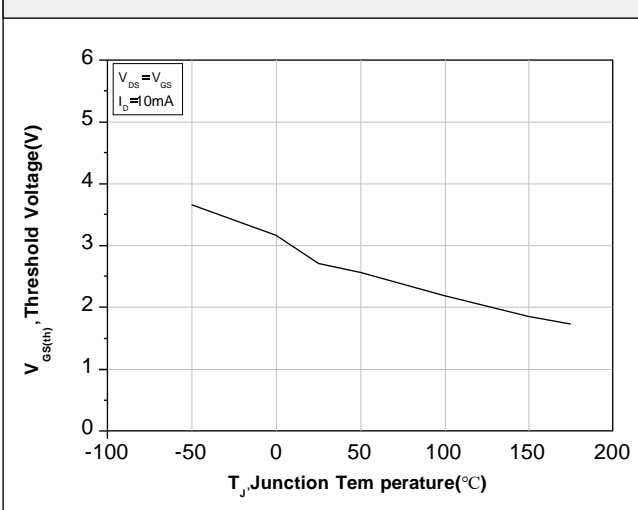

Figure 10. Gate Charge Characteristics

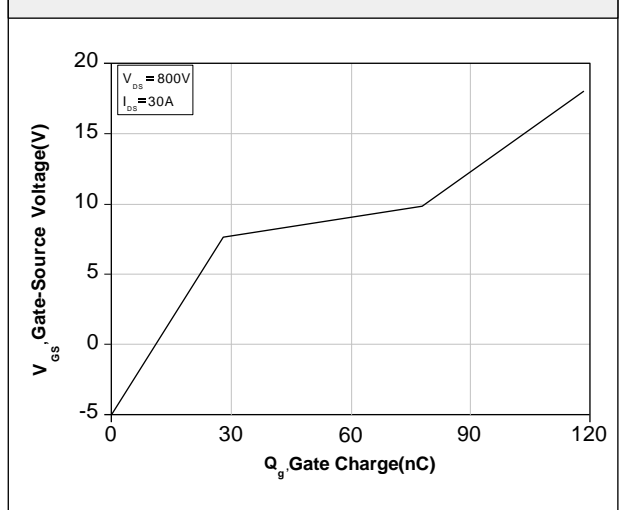

Figure 11. Stored Energy in Output Capacitance (0-800V)

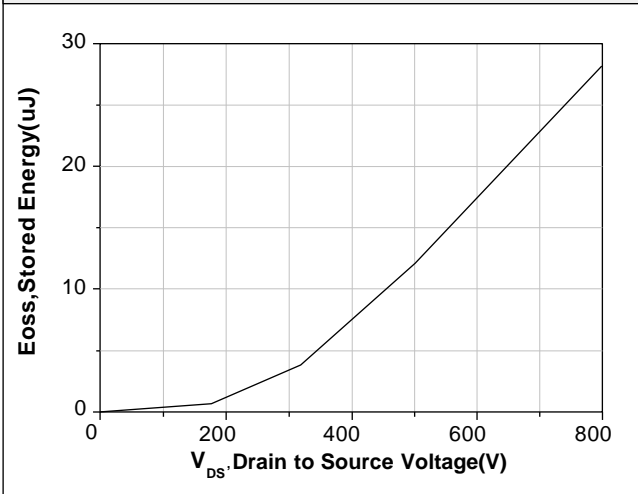
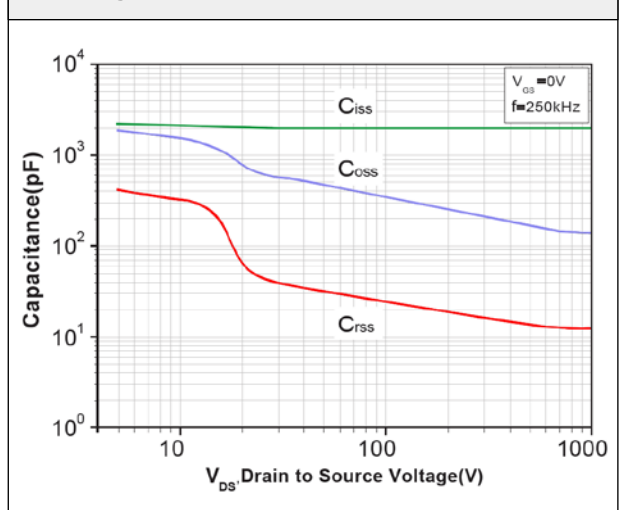

Figure 12. Capacitance Characteristics



Typical Performance Characteristics

Figure 13. Continuous Drain Current Derating vs. Case Temperature

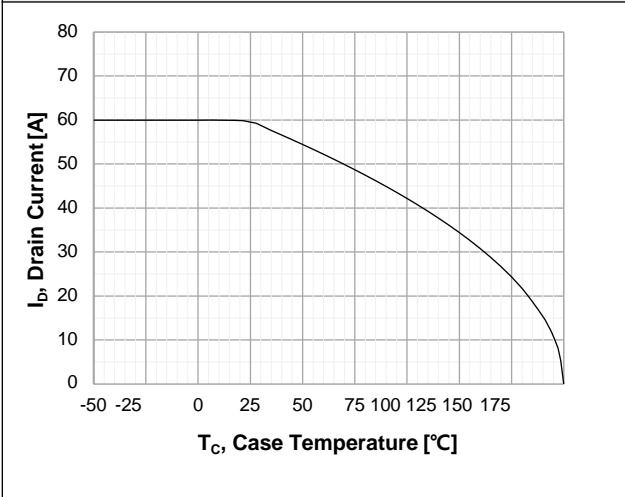

Figure 14. Maximum Power Dissipation Derating vs. Case Temperature

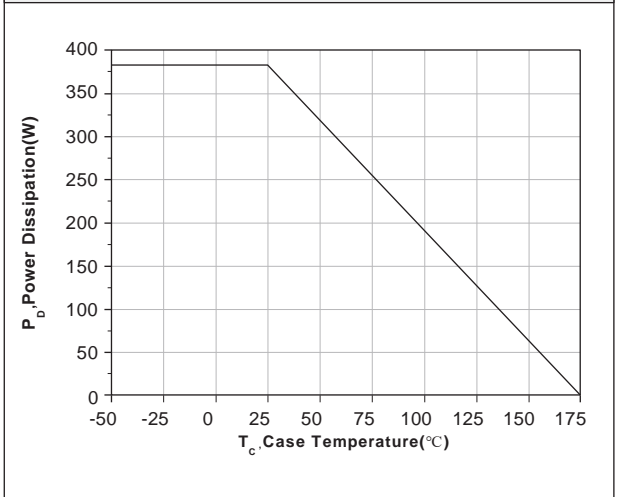

Figure 15. Typ. Switching losses vs. Drain current

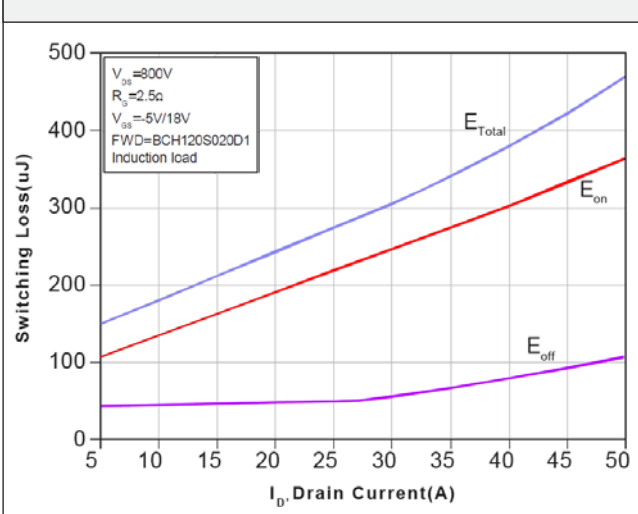

Figure 16. Typ. Switching losses vs. Gate resistance

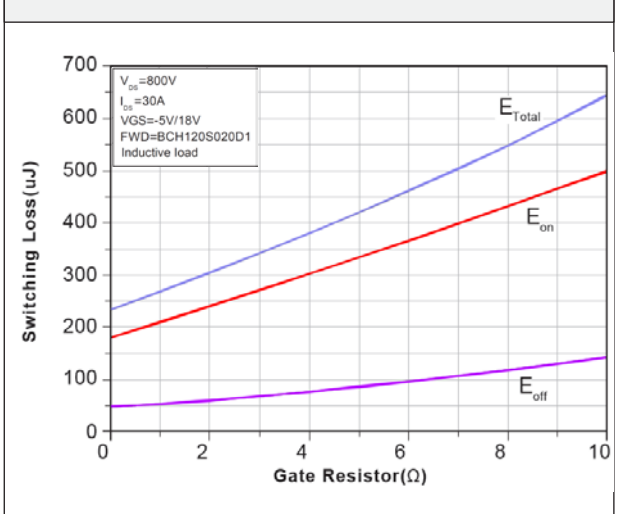

Figure 17. Typ. Switching losses vs. Drain current

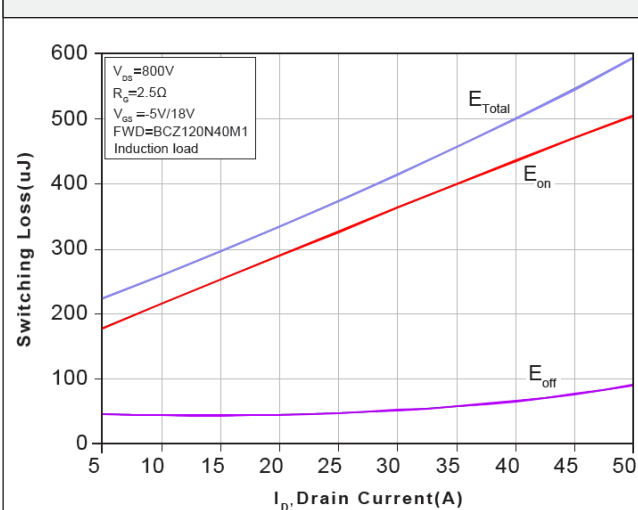
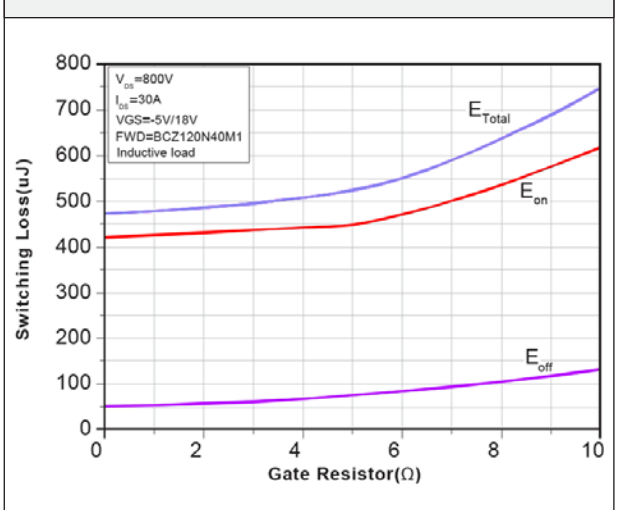

Figure 18. Typ. Switching losses vs. Gate resistance



Typical Performance Characteristics

Figure 19. Maximum Safe Operating Area

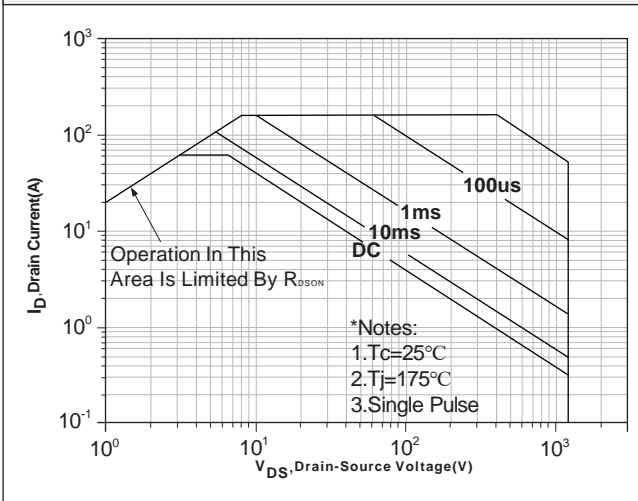

Figure 20. Transient Thermal Response Curve

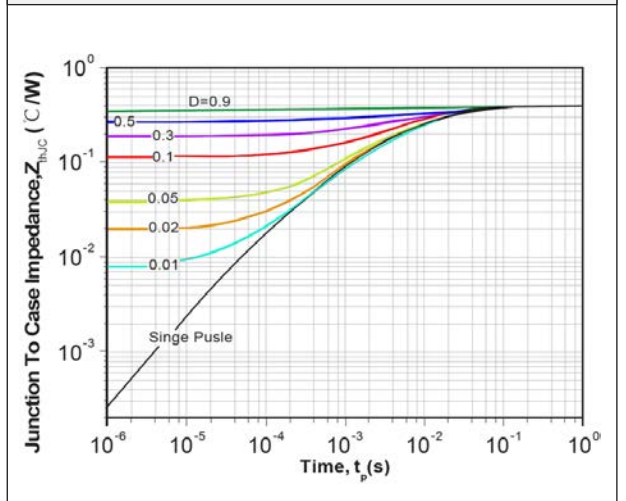

Figure 21. On-Resistance vs. Drain Current For Various Temperature

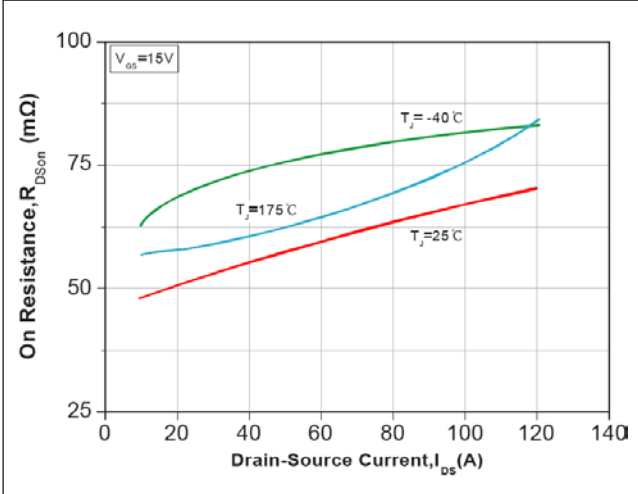

Figure 22. On-Resistance vs. Temperature For Various Gate Voltage

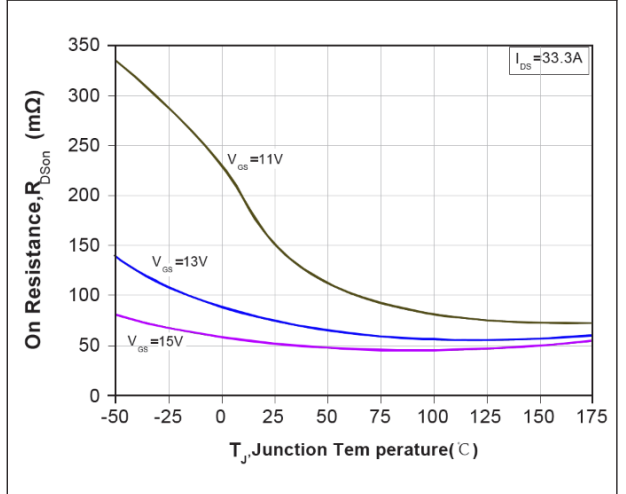

Figure 23. 3rd Quadrant Characteristic at -40°C

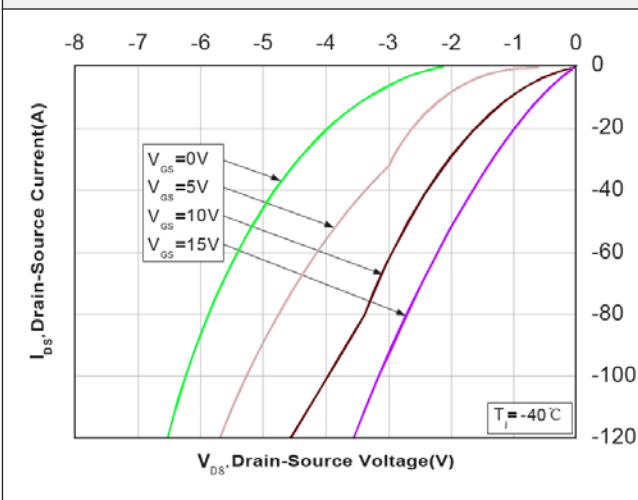
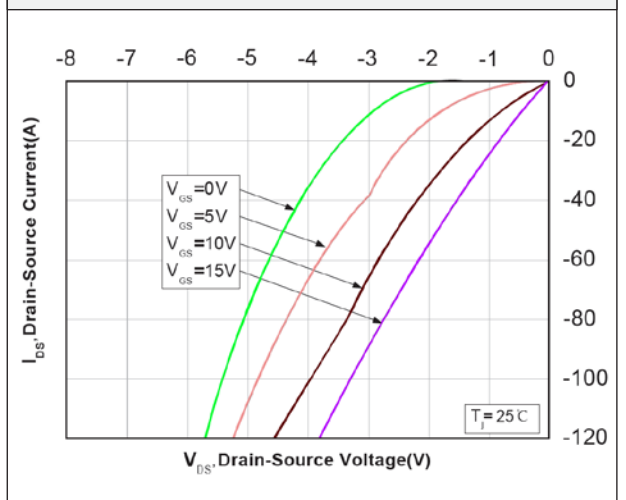
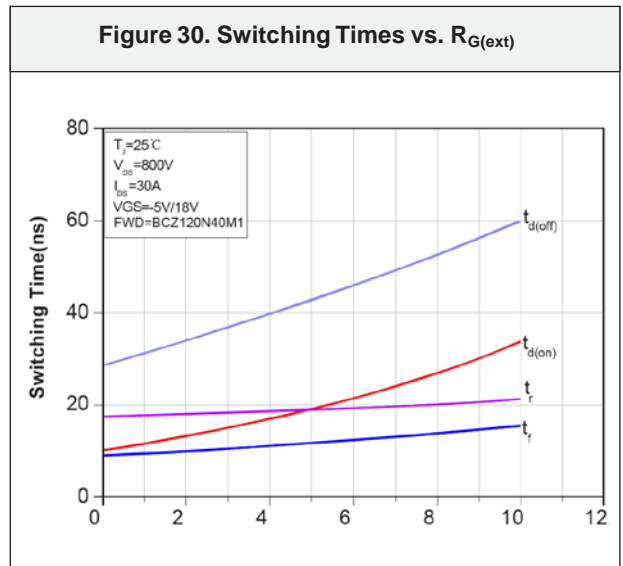
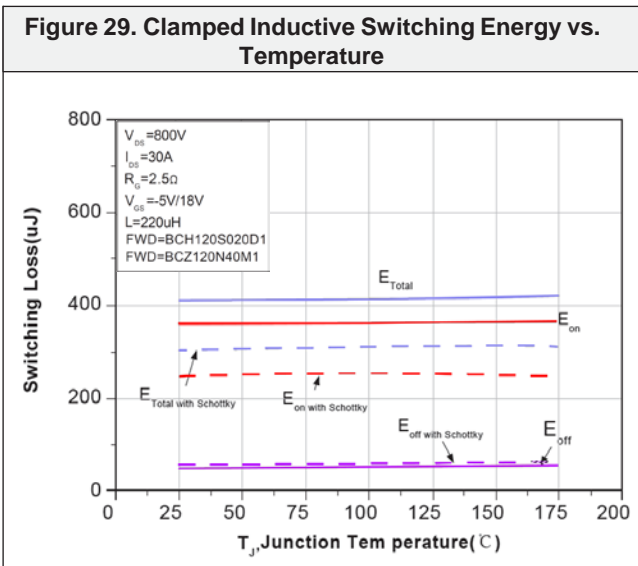
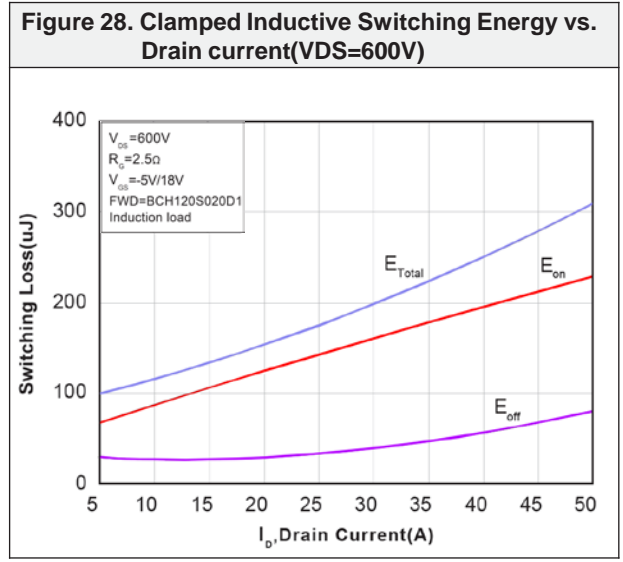
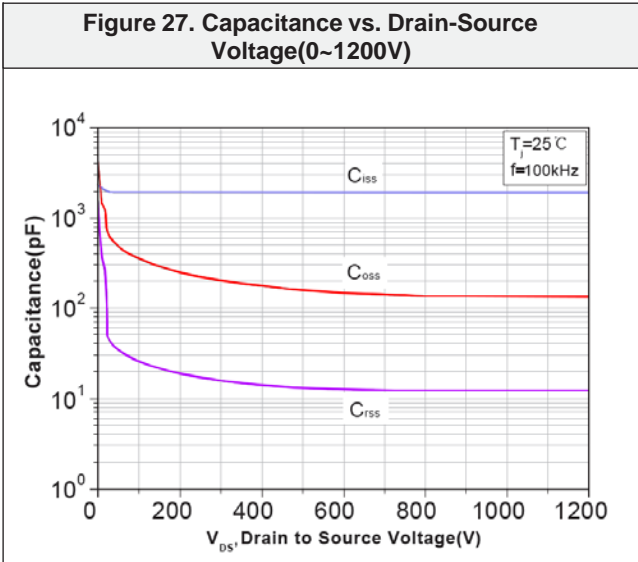
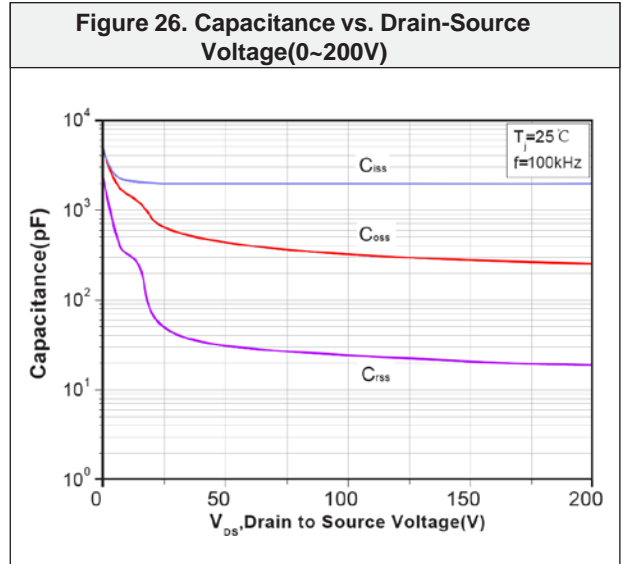
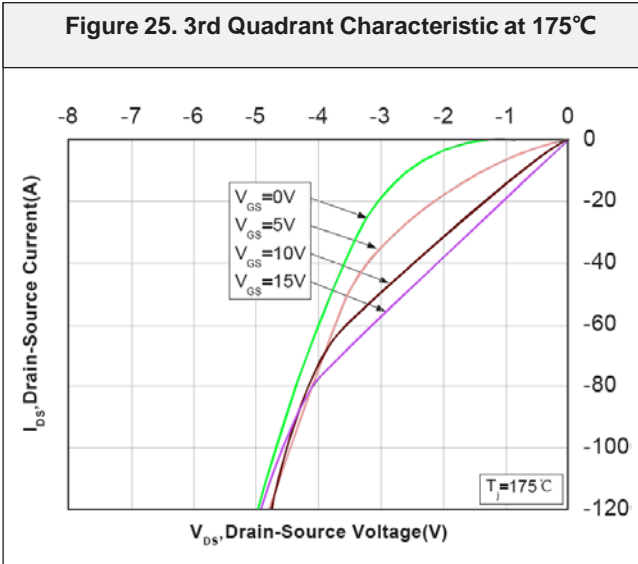

Figure 24. 3rd Quadrant Characteristic at 25°C



Typical Performance Characteristics



Typical Performance Characteristics

Figure 31. Switching Times vs. $R_{G(ext)}$

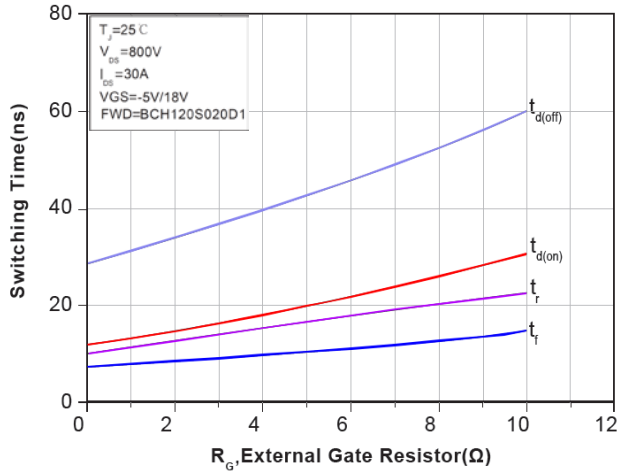

Figure 32. Stored Energy in Output Capacitance (0~1200V)

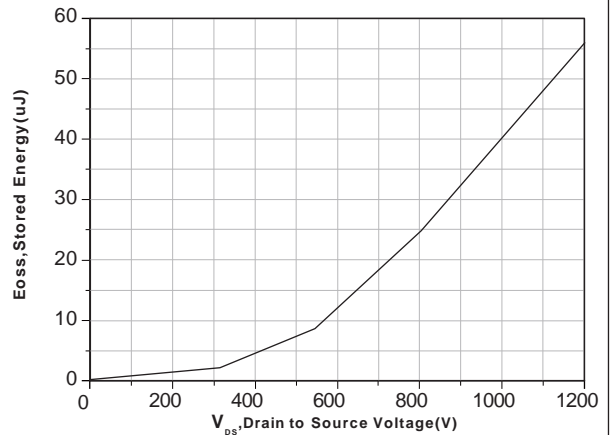

Figure 33. Inductive Load Switching Test Circuit and Waveforms

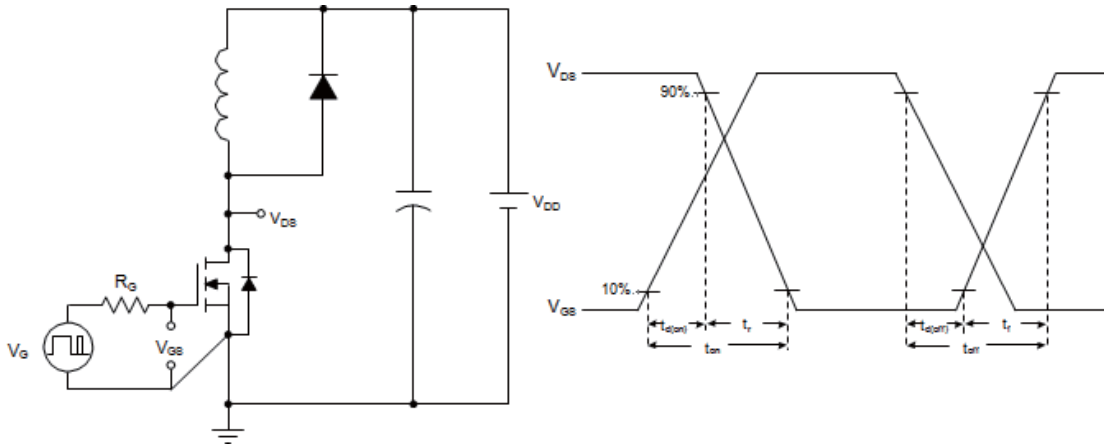
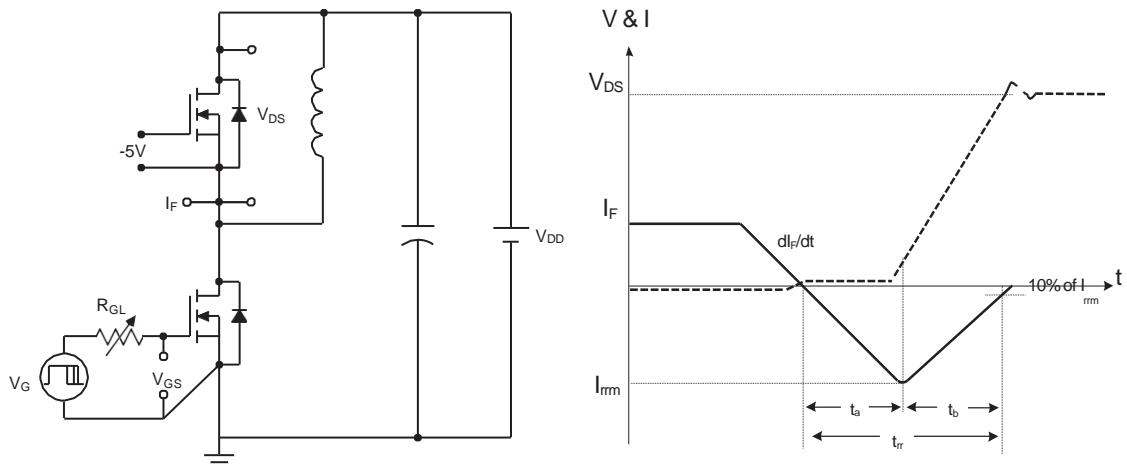
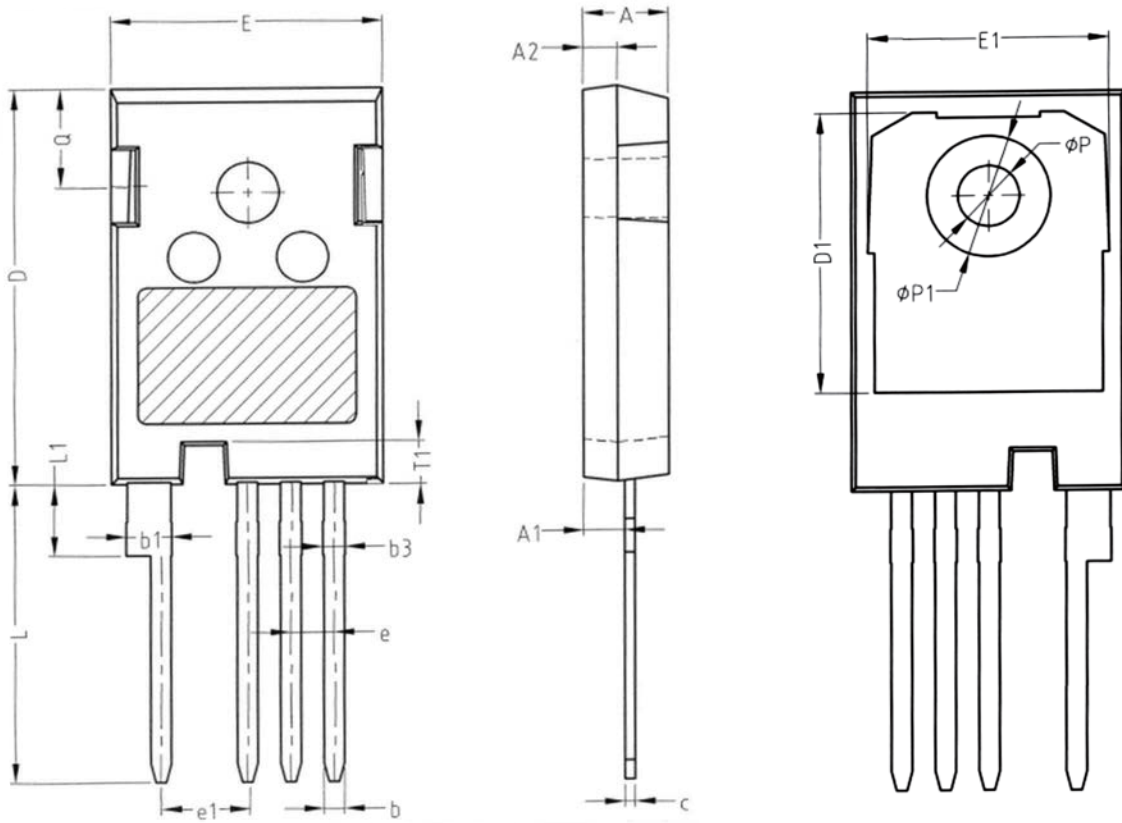

Figure 34. Peak Diode Recovery dv/dt Test Circuit and Waveforms



Package Outlines

TO247-4



SYMBOL	NM		
	MIN	NOM	MAX
A	4.80	5.00	5.20
A1	2.21	2.41	2.61
A2	1.80	2.00	2.20
b	1.06	1.21	1.36
b1	2.33	2.63	2.93
b3	1.07	1.30	1.60
c	0.51	0.61	0.75
D	23.30	23.45	23.60
D1	16.25	16.55	16.85
E	15.74	15.94	16.14
E1	13.72	14.02	14.32
T1	2.35	2.50	2.65
e	2.54 BSC		
e1	5.08 BSC		
Q	5.49	5.79	6.09
L	17.27	17.57	17.87
L1	3.99	4.19	4.39
Φp	3.40	3.60	3.80
Φp1	7.19 REF		

* Dimensions in millimeters

Package Marking and Ordering Information

Part Number	Top Marking	Package	Packing Method	Quantity
BCZ120N40M1	BCZ120N40M1	TO247-4L	Tube	30 units

Disclaimer

Bestirpower reserve the right to make changes, corrections, enhancements, modifications, and improvements to Bestirpower products and/or to this document at any time without notice.

The information given in this document shall in no event be regarded as a guarantee of conditions or characteristics. Bestirpower does not assume any liability for infringement of patents, copyrights, or other intellectual property rights of third parties by or arising from the use of Products or technical information described in this document.

This document is the property of Bestirpower Co., LTD., and not allowed to copy or transformed to other format if not under the authority approval.

© 2023 Bestirpower – All rights reserved