

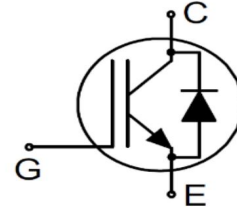

Features

- 650V, 75A IGBT
- Easy paralleling capability due to positive temperature coefficient in $V_{CE(SAT)}$
- Low EMI
- Low Gate Charge
- Low Saturation Voltage $V_{CE(SAT)}$
- Maximum junction temperature $T_{VJmax}=175^{\circ}C$



Application

- UPS
- EV-Charger
- Solar String Inverter
- Energy Storage Inverter

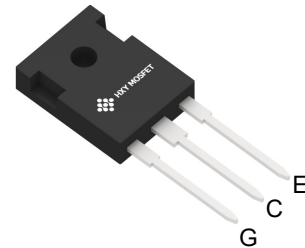

Key Performance and Package Parameters

Device	V_{CE}	I_C ($T_C = 25^{\circ}C$)	$V_{CE(SAT)}$ ($T_{VJ} = 25^{\circ}C$, $V_{GE} = 15V$)	V_F ($T_{VJ} = 25^{\circ}C$, $I_F = 40A$)	Package	Packing
IRGP4790-EPBF	650V	75A	1.6 V	1.85V	TO-247	30PCS

Absolute Maximum Ratings (@ $T_{VJ} = 25^{\circ}C$ unless otherwise specified)

Symbol	Parameter	Value	Units
V_{CE}	Collector emitter voltage	650	V
I_C	DC collector current ⁽¹⁾	$T_C = 25^{\circ}C$	90
		$T_C = 100^{\circ}C$	75
I_{CM}	Pulsed collector current	$T_C = 25^{\circ}C$	300
I_F	Maximum Diode forward current ⁽¹⁾	$T_C = 25^{\circ}C$	90
		$T_C = 100^{\circ}C$	75
I_{FM}	Diode pulsed current	$T_C = 25^{\circ}C$	300
V_{GE}	Gate-Emitter voltage	$T_{VJ} = 25^{\circ}C$	± 20
	Transient Gate-Emitter Voltage ($t_p \leq 10\mu s$, $D < 0.010$)	$T_{VJ} = 25^{\circ}C$	± 30
P_{tot}	Power Dissipation	$T_C = 25^{\circ}C$	330
		$T_C = 100^{\circ}C$	160
T_{VJ}	Operating Junction Temperature Range	-40 to +175	$^{\circ}C$
T_{STG}	Storage Temperature Range	-55 to +150	$^{\circ}C$



Thermal Resistance

Symbol	Parameter	Conditions	Max.	Unit
$R_{\theta JA}$	Thermal resistance: junction - ambient		40	°C/W
$R_{\theta JC}$	IGBT Thermal resistance: junction - case	IGBT	0.45	°C/W
$R_{\theta JC}$	Diode Thermal resistance: junction - case	Diode	0.54	°C/W

Electrical Characteristics (@ $T_{VJ} = 25^{\circ}\text{C}$ unless otherwise specified)

Symbol	Parameter	Conditions	Min.	Typ.	Max.	Unit
Static Characteristics						
$V_{(BR)CES}$	Collector - Emitter Breakdown Voltage	$V_{GE} = 0V, I_C = 0.5mA$	650	-	-	V
V_{CESAT}	Collector - Emitter Saturation Voltage	$V_{GE} = 15V, I_C = 75A$	-	1.6	2.1	V
		$V_{GE} = 15V, I_C = 75A, T_{VJ} = 125^{\circ}\text{C}$	-	1.86	-	V
		$V_{GE} = 15V, I_C = 75A, T_{VJ} = 175^{\circ}\text{C}$	-	2.0	-	V
V_F	Diode forward voltage	$V_{GE} = 0V, I_C = 75A$	-	1.85	2.1	V
		$V_{GE} = 0V, I_C = 75A, T_{VJ} = 125^{\circ}\text{C}$	-	1.55	-	V
		$V_{GE} = 0V, I_C = 75A, T_{VJ} = 175^{\circ}\text{C}$	-	1.4	-	V
$V_{GE(th)}$	Gate-Emitter threshold voltage	$V_{GE} = V_{CE}, I_C = 250\mu A$	3.2	4	4.8	V
I_{CES}	Zero Gate voltage Collector current	$V_{CE} = 650V, V_{GE} = 0V$	-	-	75	μA
I_{GES}	Gate-Emitter leakage current	$V_{GE} = \pm 20V, V_{CE} = 0V$	-	-	± 100	nA
g_{fs}	Transconductance	$V_{GE} = 20V, I_C = 75A$	-	86	-	S
Dynamic Characteristics						
C_{ies}	Input Capacitance	$V_{GE} = 0V, V_{CE} = 25V,$ $f = 1MHz$	-	2810	-	pF
C_{oes}	Output Capacitance		-	215	-	pF
C_{res}	Reverse Transfer Capacitance		-	23	-	pF
Q_g	Gate Charge	$V_{GE} = 0 \text{ to } 15V$ $V_{CE} = 520V, I_C = 75A$	-	104	-	nC
Q_{ge}	Gate to Emitter charge		-	15	-	nC
Q_{gc}	Gate to Collector charge		-	30	-	nC
Switching Characteristics						
$t_{d(on)}$	Turn-On DelayTime	$V_{GE} = 15V, V_{CC} = 400V$ $I_C = 75A, R_{G(off)} = 8\Omega$	-	20	-	ns
t_r	Turn-On Rise Time		-	30	-	ns
$t_{d(off)}$	Turn-Off DelayTime		-	130	-	ns
t_f	Turn-Off Fall Time		-	32	-	ns
E_{on}	Turn-on energy		-	2.04	-	mJ
E_{off}	Turn-off energy		-	0.92	-	mJ
E_{ts}	Total switching energy		-	2.96	-	mJ
Diode Recovery Characteristics						
T_{rr}	Reverse recovery time	$V_R = 400V, I_F = 75A,$ $di/dt = 800A/\mu S$	-	95	-	ns
Q_{rr}	Reverse recovery charge		-	1.87	-	μC
I_{rrm}	Peak reverse recovery current		-	8.0	-	A

Notes: 1. The max Collector current rating is package limited



Typical Performance Characteristics

Fig.1 Output Output characteristics (25°C)

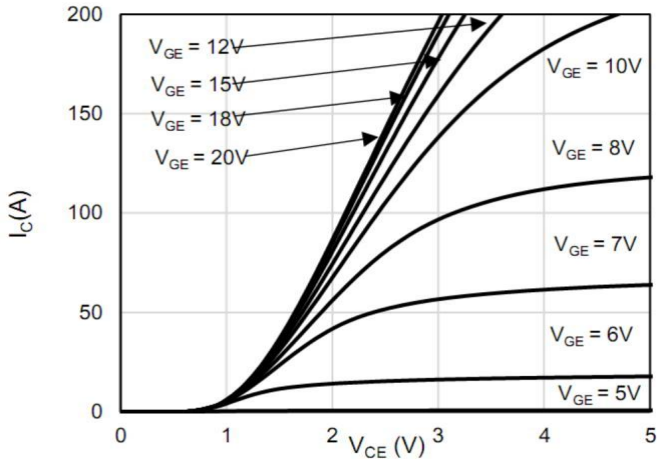

Fig.2 Output Output characteristics (150°C)

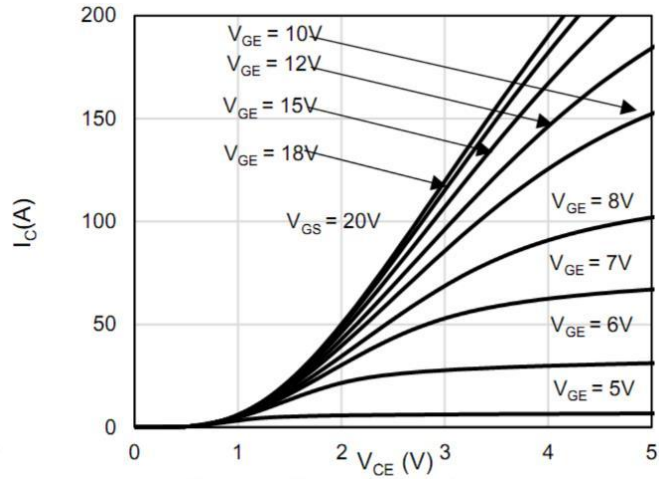

Fig.3 Power dissipation as a function of case temperature ($T_{vj} \leq 175^\circ\text{C}$)

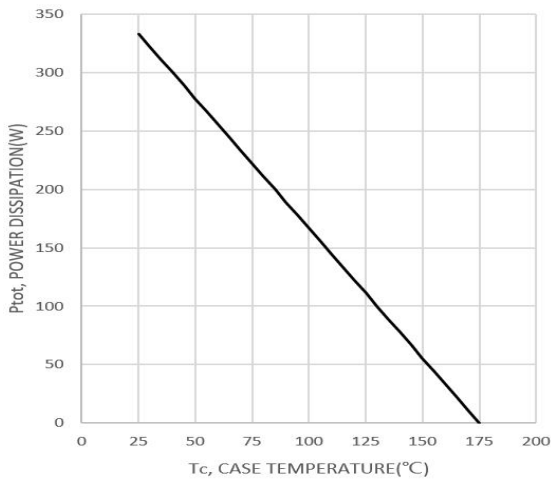

Fig.4 Collector current as a function of case temperature ($V_{GE} \geq 15\text{V}$, $T_{vj} \leq 175^\circ\text{C}$)

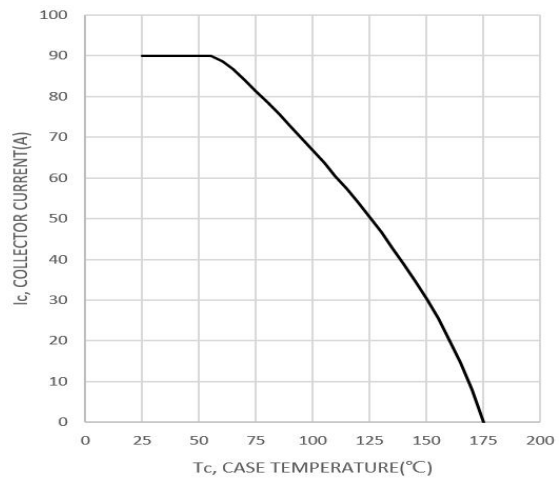

Fig.5 Forward Bias Safe Operating Area

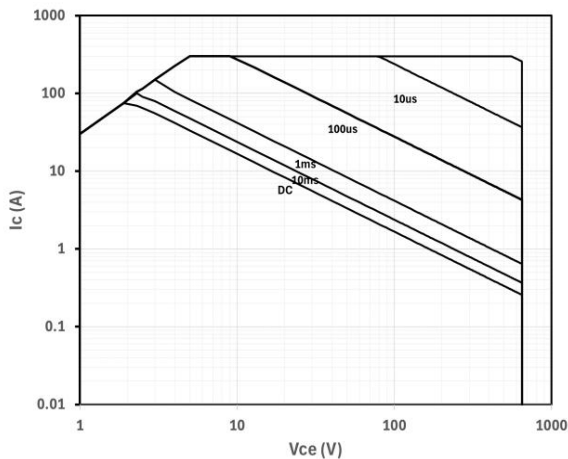

Fig.6 Transfer characteristics

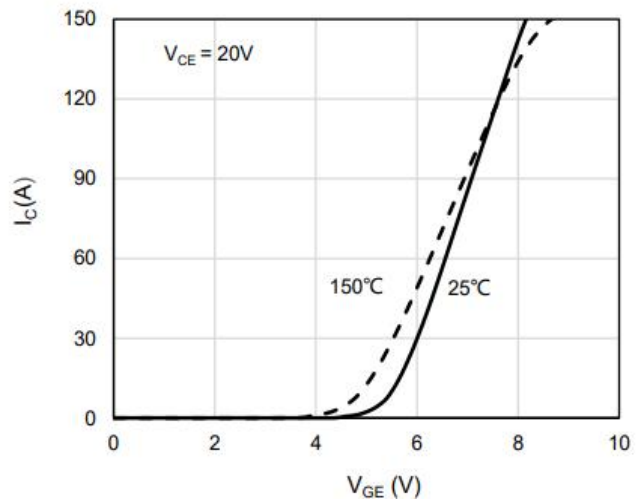



Fig.7 Gate charge

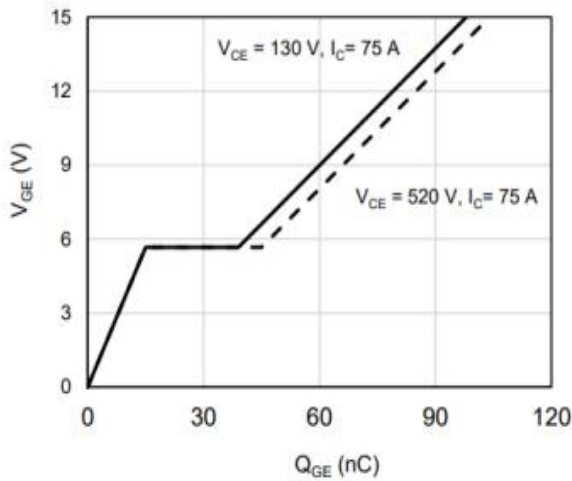

Fig.8 Typical capacitance

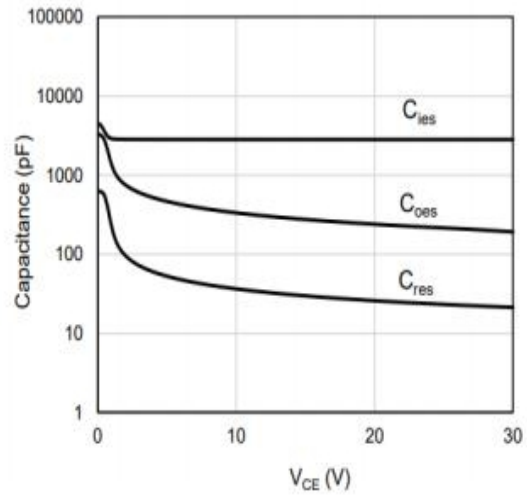

Fig.9 Vcesat vs. Junction Current

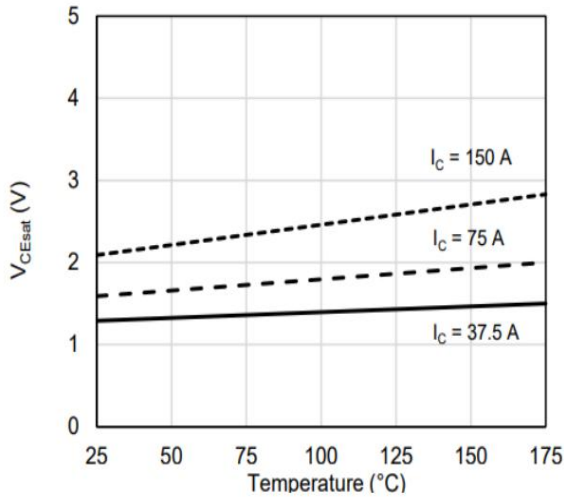

Fig.10 Typical diode VF vs. IF Characteristics

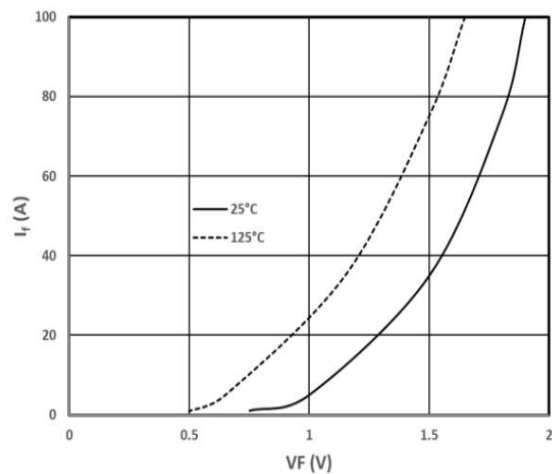

Fig.11 Threshold voltage vs. Junction temperature

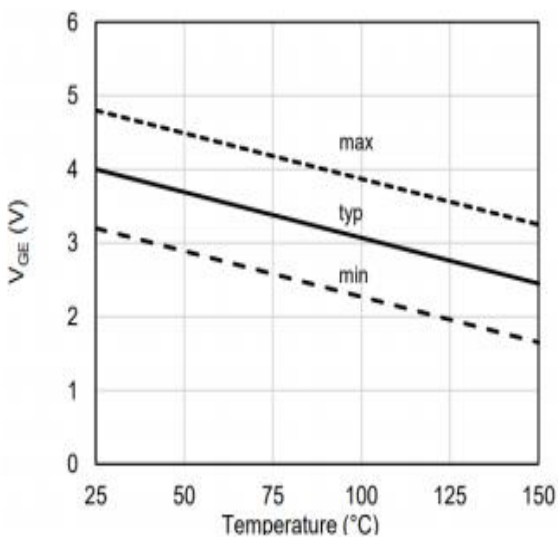

Fig.12 Switching Energy Loss vs. collector current

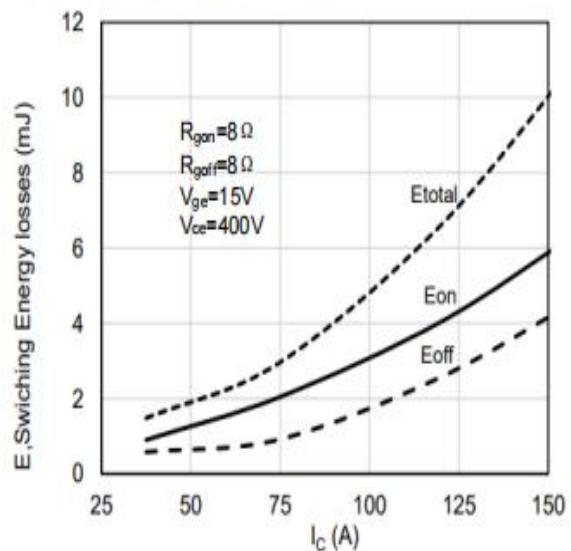



Fig.13 Switching Energy Loss vs. Rg

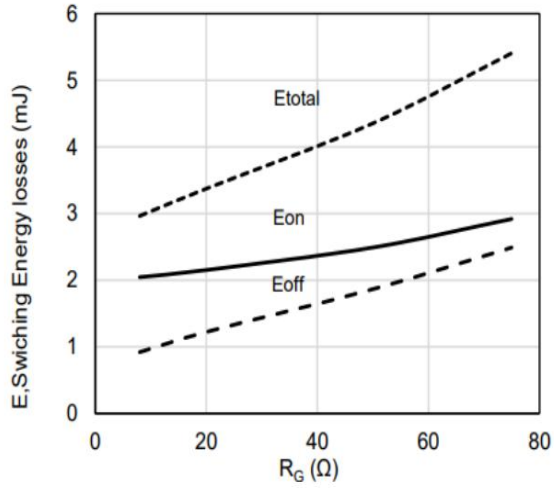

Fig.14 Transient Thermal Impedance IGBT

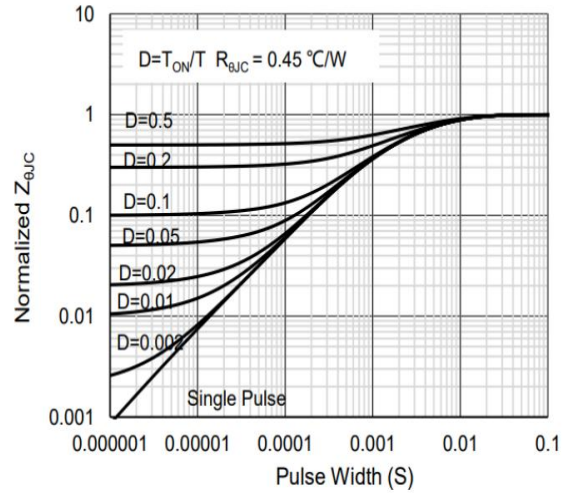
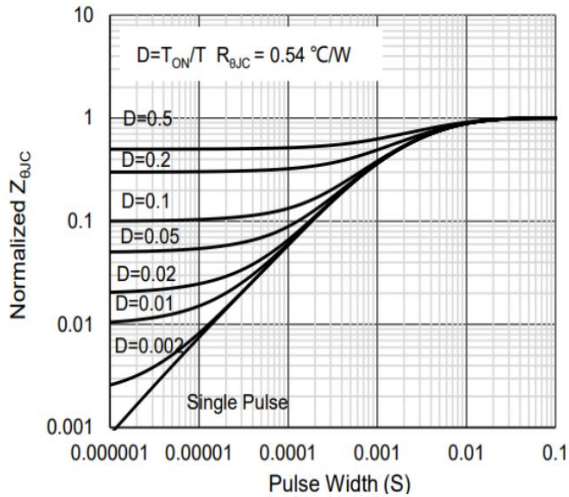

Fig.15 Transient Thermal Impedance Diode





Test Circuit

Switching Test Circuit & Waveforms

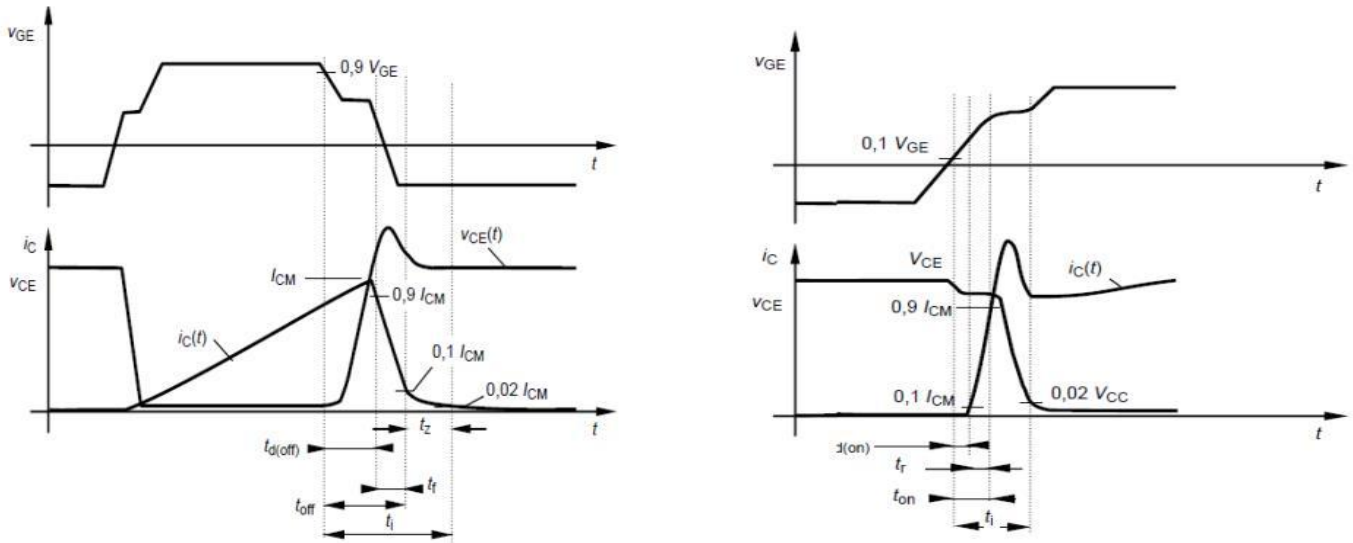

Diode Recovery Test Circuit & Waveforms

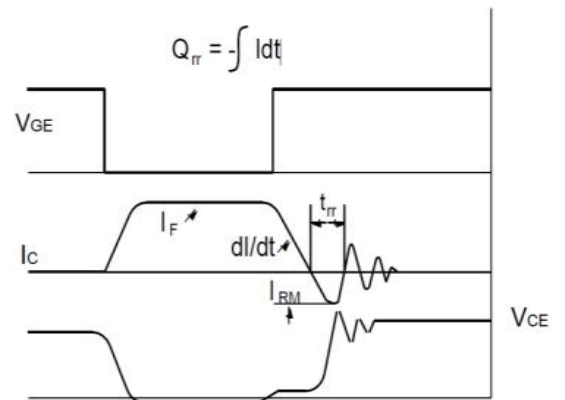
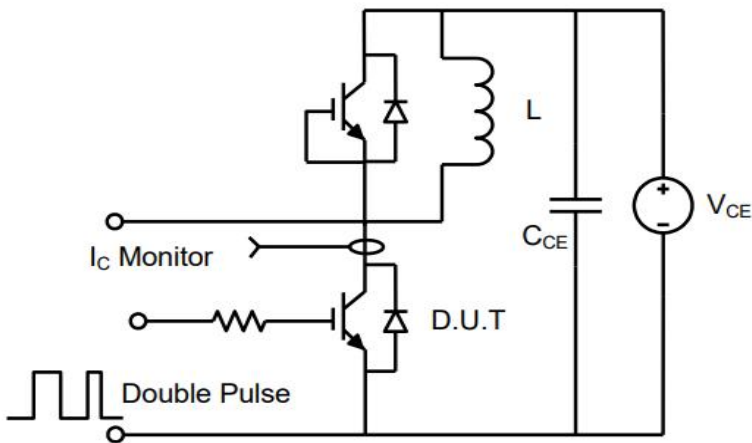



Package Mechanical Data(TO-247)

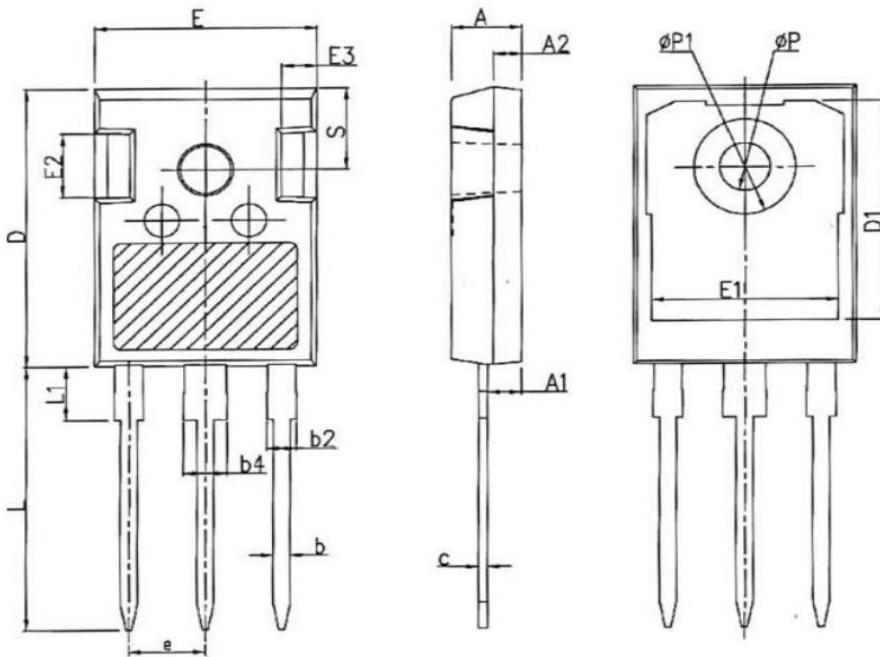

SYMBOL	mm		
	MIN	NOM	MAX
A	4.80	5.00	5.20
A1	2.21	2.41	2.59
A2	1.85	2.00	2.15
b	1.11	1.21	1.36
b2	1.91	2.01	2.21
b4	2.91	3.01	3.21
c	0.51	0.61	0.75
D	20.70	21.00	21.30
D1	16.25	16.55	16.85
E	15.50	15.80	16.10
E1	13.00	13.30	13.60
E2	4.80	5.00	5.20
E3	2.30	2.50	2.70
e	5.44BSC		
L	19.62	19.92	20.22
L1	-	-	4.30
ϕP	3.40	3.60	3.80
$\phi P1$	-	-	7.30
S	6.15BSC		



Attention

- Any and all HUA XUAN YANG ELECTRONICS products described or contained herein do not have specifications that can handle applications that require extremely high levels of reliability, such as life-support systems, aircraft's control systems, or other applications whose failure can be reasonably expected to result in serious physical and/or material damage. Consult with your HUA XUAN YANG ELECTRONICS representative nearest you before using any HUA XUAN YANG ELECTRONICS products described or contained herein in such applications.
- HUA XUAN YANG ELECTRONICS assumes no responsibility for equipment failures that result from using products at values that exceed, even momentarily, rated values (such as maximum ratings, operating condition ranges, or other parameters) listed in products specifications of any and all HUA XUAN YANG ELECTRONICS products described or contained herein.
- Specifications of any and all HUA XUAN YANG ELECTRONICS products described or contained herein stipulate the performance, characteristics, and functions of the described products in the independent state, and are not guarantees of the performance, characteristics, and functions of the described products as mounted in the customer's products or equipment. To verify symptoms and states that cannot be evaluated in an independent device, the customer should always evaluate and test devices mounted in the customer's products or equipment.
- HUA XUAN YANG ELECTRONICS CO.,LTD. strives to supply high-quality high-reliability products. However, any and all semiconductor products fail with some probability. It is possible that these probabilistic failures could give rise to accidents or events that could endanger human lives, that could give rise to smoke or fire, or that could cause damage to other property. When designing equipment, adopt safety measures so that these kinds of accidents or events cannot occur. Such measures include but are not limited to protective circuits and error prevention circuits for safe design, redundant design, and structural design.
- In the event that any or all HUA XUAN YANG ELECTRONICS products(including technical data, services) described or contained herein are controlled under any of applicable local export control laws and regulations, such products must not be exported without obtaining the export license from the authorities concerned in accordance with the above law.
- No part of this publication may be reproduced or transmitted in any form or by any means, electronic or mechanical, including photocopying and recording, or any information storage or retrieval system, or otherwise, without the prior written permission of HUA XUAN YANG ELECTRONICS CO.,LTD.
- Information (including circuit diagrams and circuit parameters) herein is for example only ; it is not guaranteed for volume production. HUA XUAN YANG ELECTRONICS believes information herein is accurate and reliable, but no guarantees are made or implied regarding its use or any infringements of intellectual property rights or other rights of third parties.
- Any and all information described or contained herein are subject to change without notice due to product/technology improvement, etc. When designing equipment, refer to the "Delivery Specification" for the HUA XUAN YANG ELECTRONICS product that you intend to use.