

■ **Features**

- Glass passivated chip
- Low reverse leakage current
- High surge current capability
- Reliable low cost construction utilizing molded plastic technique

Reverse Voltage 50-1000 V
Forward Current 15.0 A max

■ **Applications**

- General purpose use in AC/DC bridge full wave rectification

■ **Mechanical Data**

- Case: 6GBJ
- Polarity symbols being marked on body
- Molding compound meets UL 94V-0 flammability rating
- RoHS-compliant, Solder plated, solderable per MIL-STD-750, Method 2026

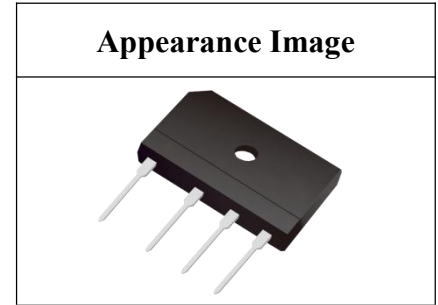

■ **Marking**

- GBJ15xx(005~10)

■ **Maximum Ratings @ Ta = 25°C unless otherwise noted**

PARAMETER	SYMBOL	UNIT	GBJ15005	GBJ1501	GBJ1502	GBJ1504	GBJ1506	GBJ1508	GBJ1510
Repetitive peak reverse voltage	V_{RRM}	V	50	100	200	400	600	800	1000
Maximum RMS voltage	V_{RMS}	V	35	70	140	280	420	560	700
Maximum DC blocking Voltage	V_{DC}	V	50	100	200	400	600	800	1000
Maximum average output current@60Hz sine wave, resistance load	$I_{F(AV)}$	A	15.0						
Peak forward surge current 8.3 ms single half sine wave superimposed on rated load	I_{FSM}	A	220						
Peak forward surge current 1.0 ms single half sine wave superimposed on rated load		A	440						
Current squared time @1ms≤t<8.3ms Tj=25°C, Rating of per diode	I^2t	A²S	200.86						
Storage temperature	T_{stg}	°C	-55 ~ +150						
Junction temperature	T_j	°C	-55 ~ +150						

■ **Electrical Characteristics @ Ta = 25°C unless otherwise noted**

PARAMETER	TEST CONDITIONS	SYMBOL	UNIT	GBJ15005	GBJ1501	GBJ1502	GBJ1504	GBJ1506	GBJ1508	GBJ1510
Maximum instantaneous forward voltage	$I_F=7.5A$	V_F	V	1.0						
Maximum DC reverse current at rated DC blocking voltage	$V_R=V_{DC}, T_j=25°C$	I_R	μA	10						
	$V_R=V_{DC}, T_j=100°C$	I_R		500						

■ **Characteristic Curve (Typical)**

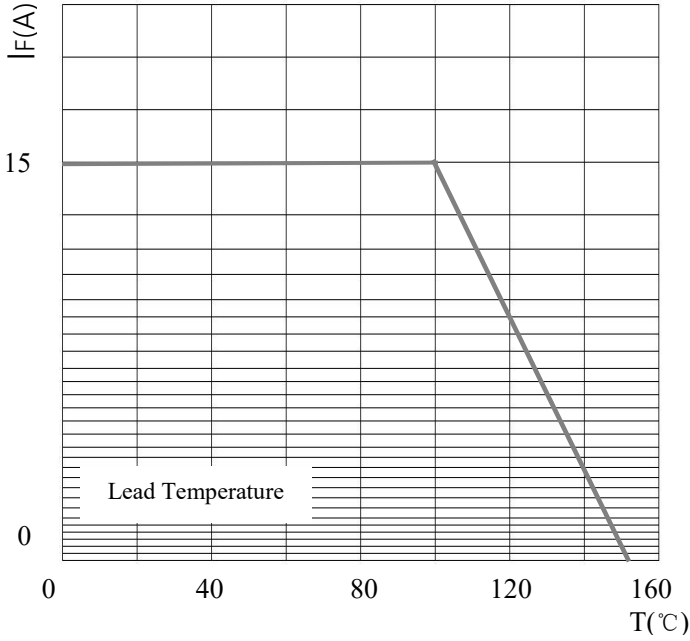

FIG1. Derating Curve For Output Rectified Current

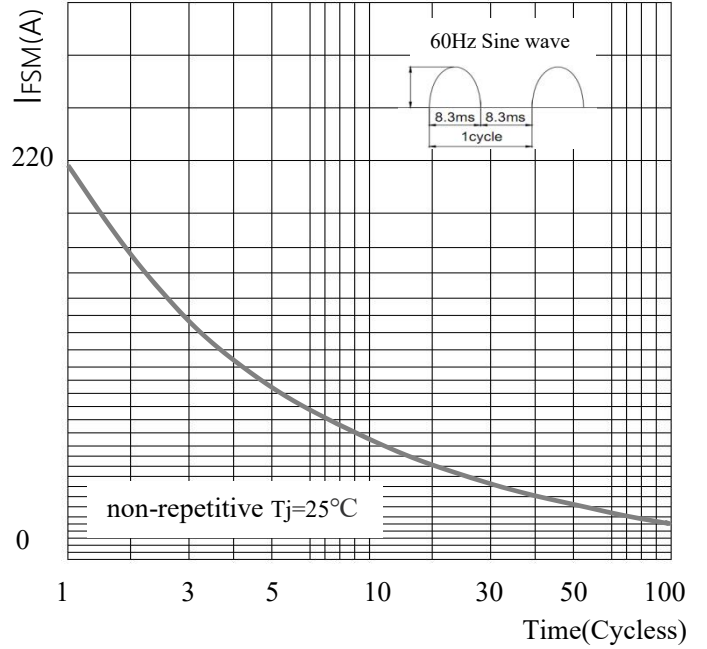

FIG2. Surge Forward Current Capability

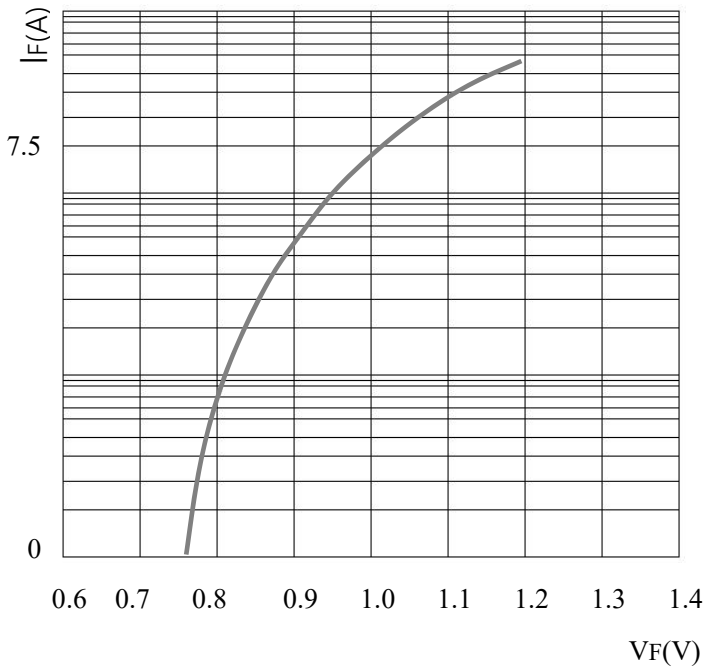

FIG3. Typical Forward Characteristics

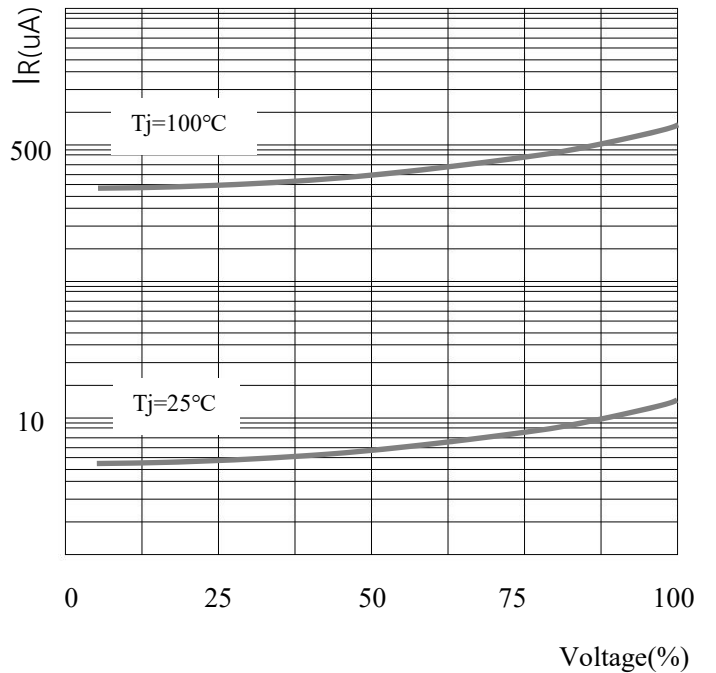
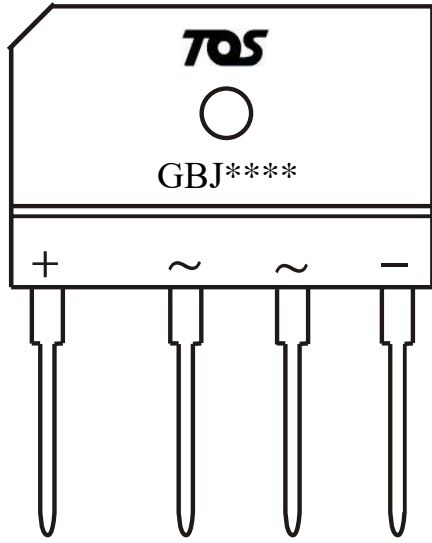

FIG4. Typical Reverse Characteristics

■ **Marking and packet information**



GBJ**** : Marking Model

TOS : Brand Logo

Packaging information	
每盒	250PCS
每箱	2000PCS
脚长定制	支持

■ **6GBJ Package outline dimensions**

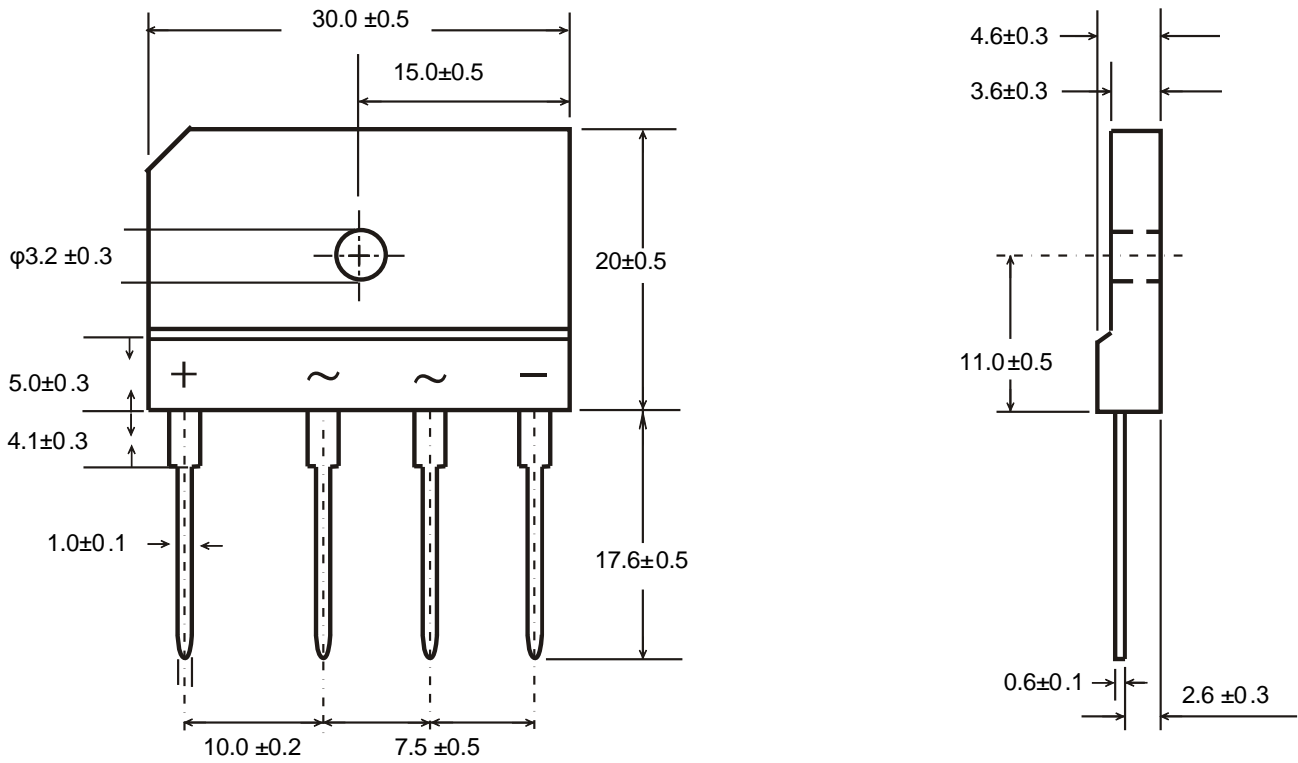

Dimensions in millimeters

■ **Notice**

XILONG reserves the right to make modifications, enhancements, improvements, corrections or other changes without further notice to any product herein. xilong does not assume any liability arising out of the application or use of any product described herein.