

■ **Features**

- Glass passivated chip
- Low reverse leakage current
- High surge current capability
- Reliable low cost construction utilizing molded plastic technique

Reverse Voltage 50-1000 V
Forward Current 25.0 A max

■ **Applications**

- General purpose use in AC/DC bridge full wave rectification

■ **Mechanical Data**

- Case: 6GBJ
- Polarity symbols being marked on body
- Molding compound meets UL 94V-0 flammability rating
- RoHS-compliant, Solder plated, solderable per MIL-STD-750, Method 2026

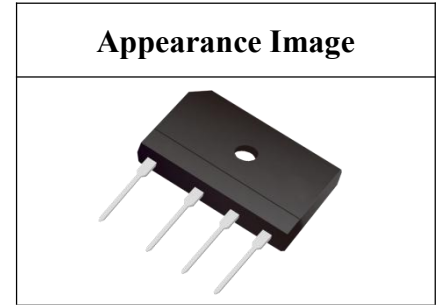

■ **Marking**

- GBJ25xx(005~10)

■ **Maximum Ratings @ Ta = 25°C unless otherwise noted**

PARAMETER	SYMBOL	UNIT	GBJ25005	GBJ2501	GBJ2502	GBJ2504	GBJ2506	GBJ2508	GBJ2510
Repetitive peak reverse voltage	V_{RRM}	V	50	100	200	400	600	800	1000
Maximum RMS voltage	V_{RMS}	V	35	70	140	280	420	560	700
Maximum DC blocking Voltage	V_{DC}	V	50	100	200	400	600	800	1000
Maximum average output current@60Hz sine wave, resistance load	$I_{F(AV)}$	A	25.0						
Peak forward surge current 8.3 ms single half sine wave superimposed on rated load	I_{FSM}	A	300						
Peak forward surge current 1.0 ms single half sine wave superimposed on rated load		A	600						
Current squared time @1ms≤t<8.3ms Tj=25°C, Rating of per diode	I^2t	A²S	373.5						
Storage temperature	T_{stg}	°C	-55~+150						
Junction temperature	T_j	°C	-55~+150						

■ **Electrical Characteristics @ Ta = 25°C unless otherwise noted**

PARAMETER	TEST CONDITIONS	SYMBOL	UNIT	GBJ25005	GBJ2501	GBJ2502	GBJ2504	GBJ2506	GBJ2508	GBJ2510
Maximum instantaneous forward voltage	$I_F=12.5A$	V_F	V	1.0						
Maximum DC reverse current at rated DC blocking voltage	$V_R=V_{DC}, T_j=25^\circ C$	I_R	μA	10						
	$V_R=V_{DC}, T_j=100^\circ C$	I_R		500						

■ **Characteristic Curve (Typical)**

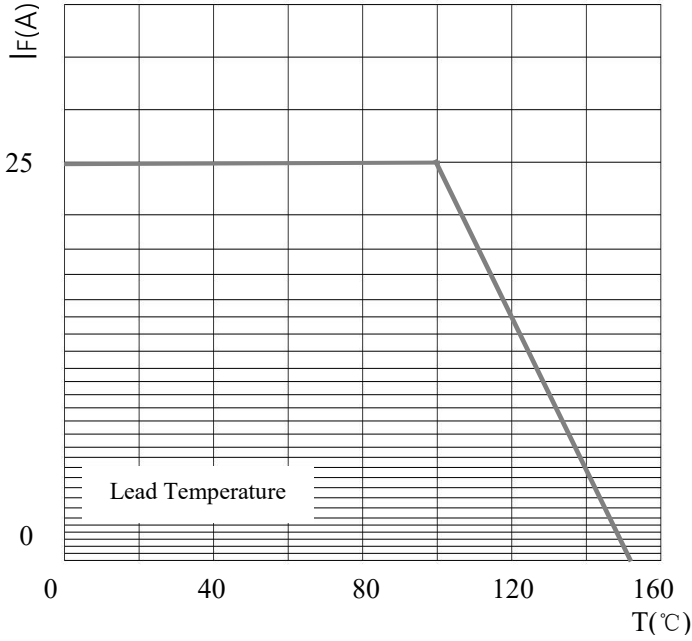

FIG1. Derating Curve For Output Rectified Current

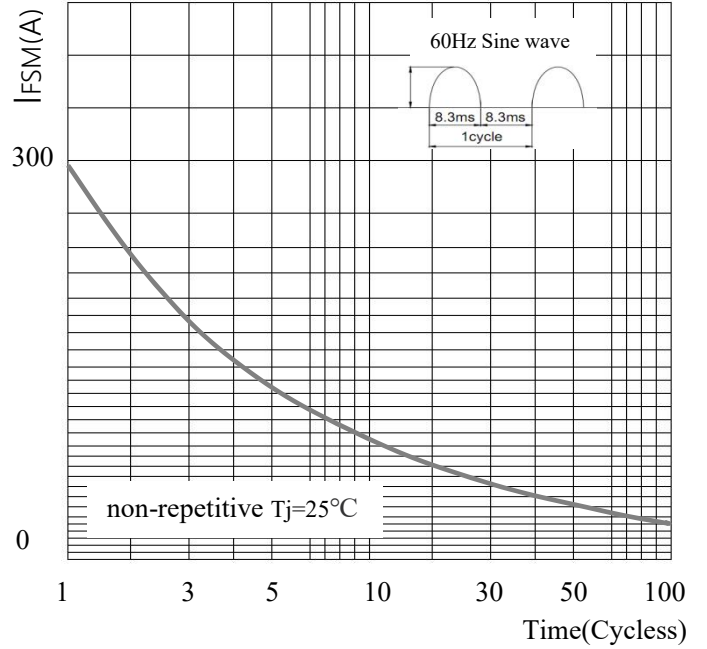

FIG2. Surge Forward Current Capability

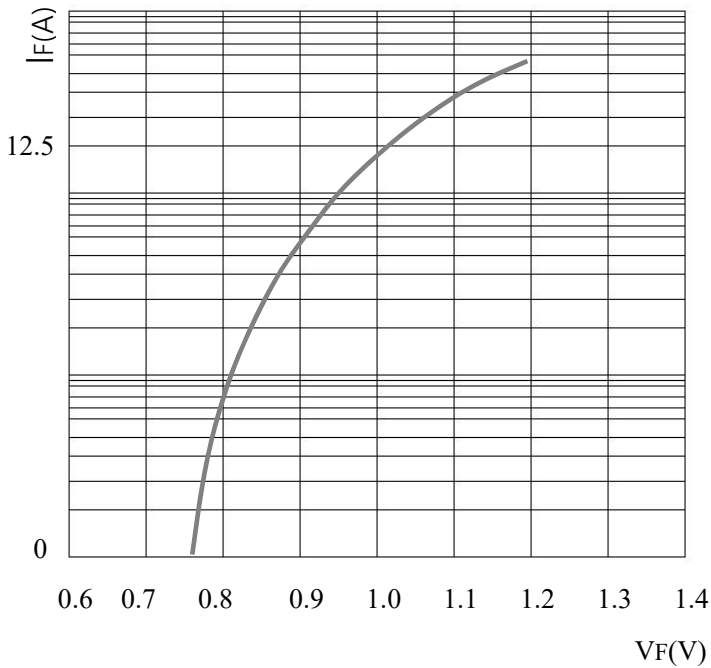

FIG3. Typical Forward Characteristics

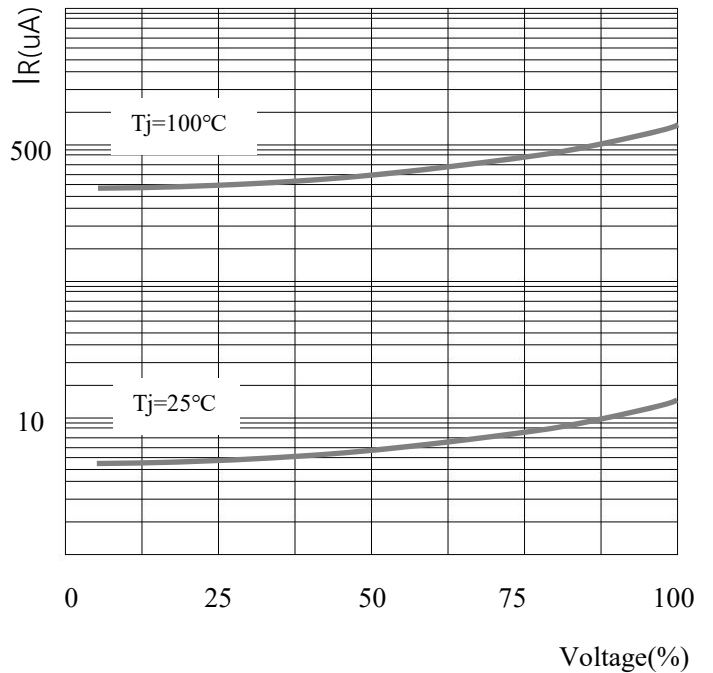
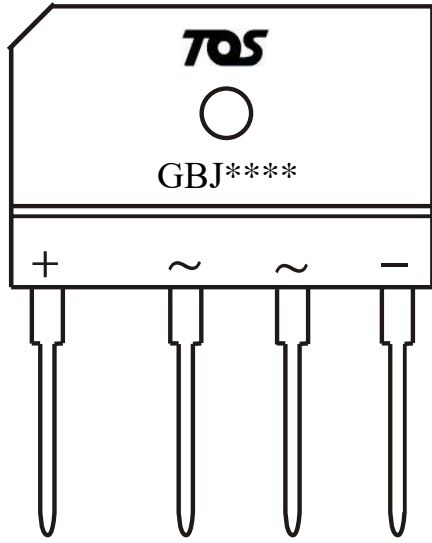

FIG4. Typical Reverse Characteristics

■ **Marking and packet information**



GBJ**** : Marking Model

TOS : Brand Logo

Packaging information	
每盒	250PCS
每箱	2000PCS
脚长定制	支持

■ **6GBJ Package outline dimensions**

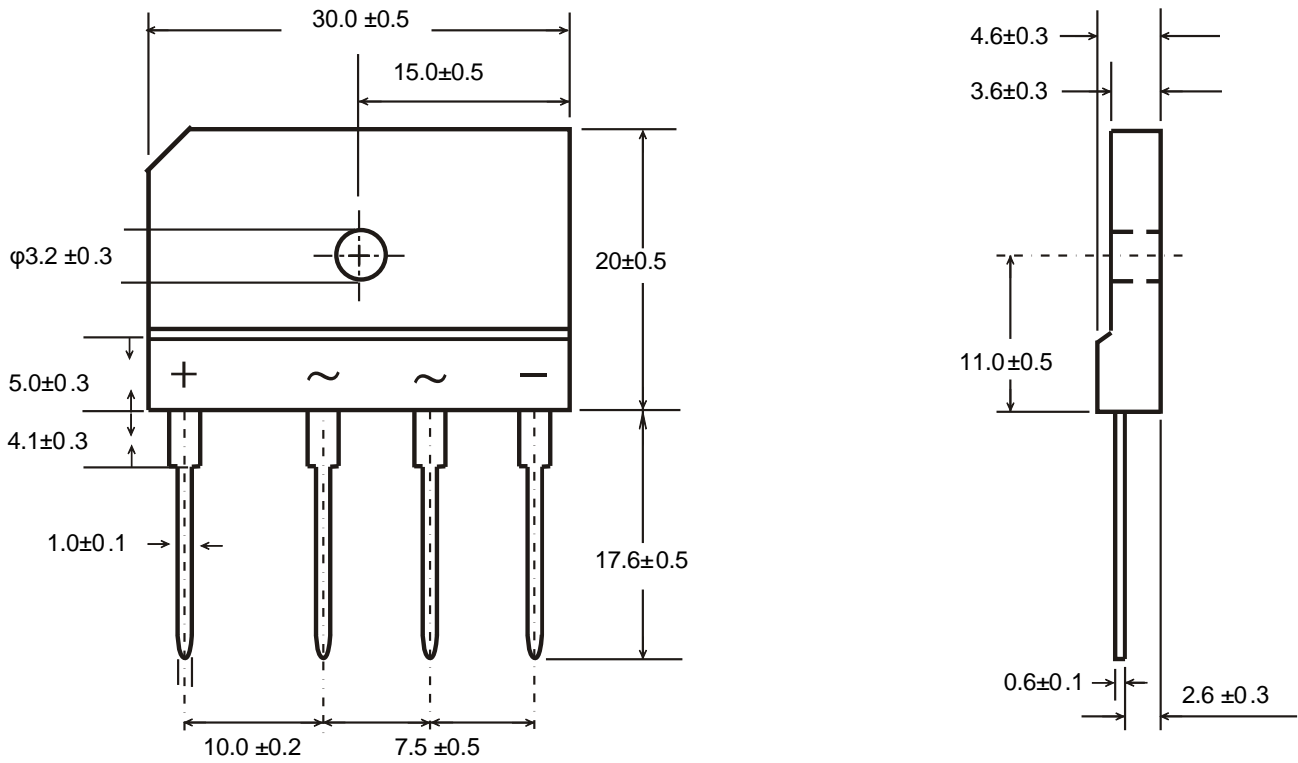

Dimensions in millimeters

■ **Notice**

XILONG reserves the right to make modifications,enhancements,improvements,corrections or other changes without further notice to any product herein.
xilong does not assume any liability arising out of the application or use of any product described herein.